

EATON

Vickers

Logical Troubleshooting in Hydraulic Systems

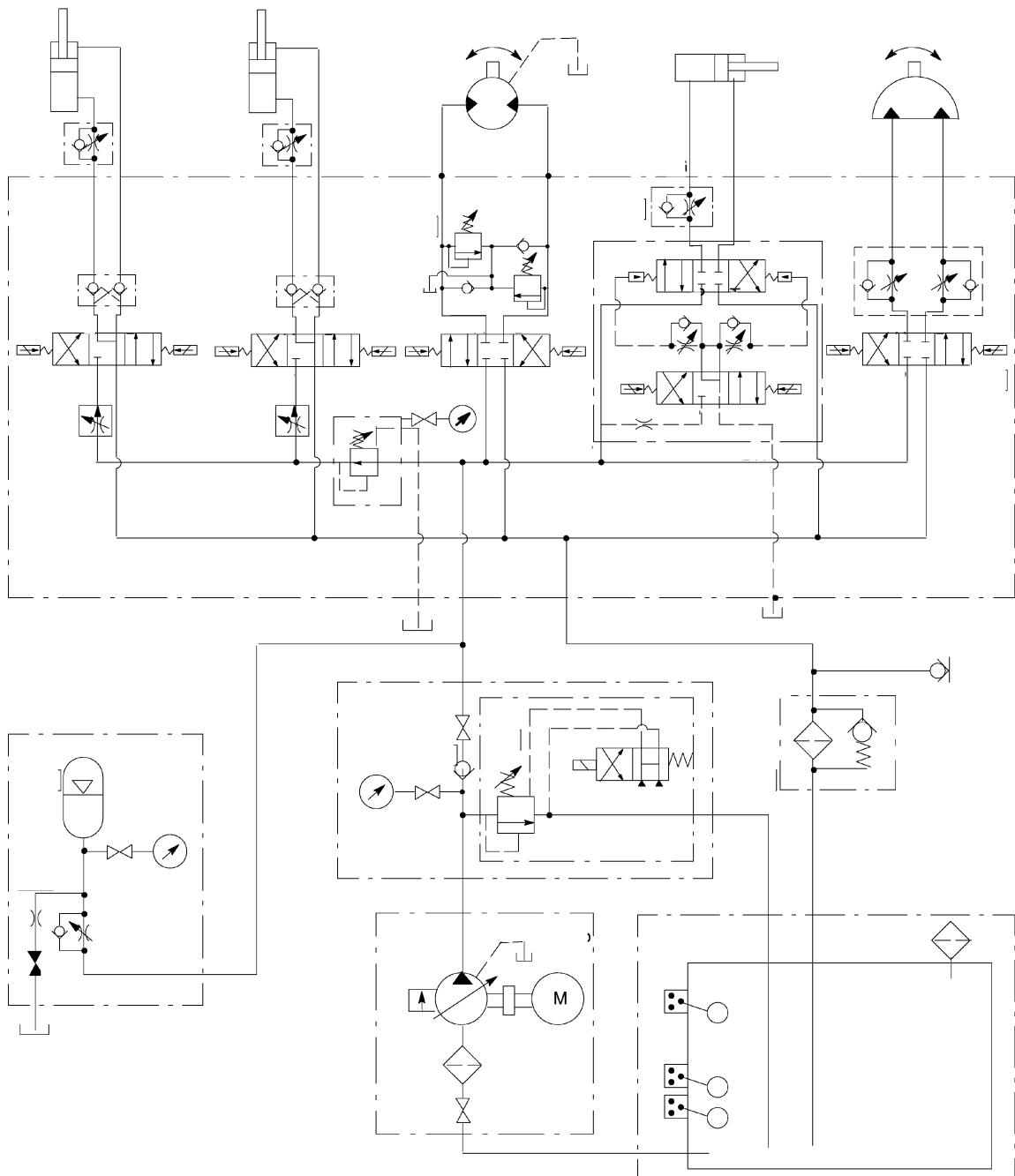

Index

Introduction	3
Shutting Down Machines	3
Line Service	3
Checking Faults	4
Instrumentation Principles and Measuring Instruments	5
Measuring instruments	6
Pressure Gauges	6
Pressure Gauge Installation	6
Flow Meters	7
Flow Meter Installation	7
Machine malfunction procedure	9
Machine faults	10
System faults	10
System malfunction	10
System faults	11
Unit Fault Preliminary Check	12
Excessive Temperature	13
Excessive Noise	14
Excessive Vibration	15
Excessive Leakage	16
System test for gear and vane pumps	17
System test for piston pumps	18
System test for pressure relief valves	20
System test for sequence valves	21
System test for pressure reducing valves	22
System test for flow control valves	23
System test for directional control valves	24
System test for pilot operated check valves	25
System test for cylinders	26
System test for hydraulic motors	27
System test for accumulators	28
System test for coolers	29
System test for air leaks	30
System test for fluid contamination	31
Pump cavitation	32
Aeration of fluid	33
Re-start procedure	34
Bar trimming machine – Troubleshooting exercise	35
Bar trimming machine layout	36
Circuit diagram for bar trimming machine	37



Warning

“Logical Troubleshooting in Hydraulic Systems” is intended as a guide to systematic fault findings in a hydraulic system. Vickers systems (to the extent permitted by law) accept no liability for loss or damage suffered as a result of the use of this guide. If in doubt, always refer to the original equipment manufacturer. Refer at all times to the “safety procedure” on pages 3 and 34.

Introduction

It would be a virtually impossible task to try to document the cause and remedy of every possible fault that could occur on even the simplest hydraulic system. For this reason it is necessary to adopt a logical approach to troubleshooting, in order to locate a fault as quickly and accurately as possible. Down time on modern production machinery is very expensive, so an hour saved in locating a problem may make hundreds, or sometimes thousands, of pounds worth of saving in lost production.

Inevitably, hydraulic systems are becoming more and more complex as methods of controlling machines become increasingly sophisticated. The last ten years has seen rapid technological advances in the components used in many hydraulic systems, and it is vital that equipment, or machine manufacturer's service information or 'software' keeps pace with the actual hardware being used.

It is probably true to say that there is still a general lack of understanding of hydraulics in some areas of industry, and in reality, the job of a hydraulic maintenance engineer is now a specialized occupation with many similarities to that of an instrument or electrical engineer.

The object of this book is to provide procedure for a logical approach to troubleshooting, which can be extended when necessary to cover specific machines in all areas of industry. The fundamentals around which this procedure is developed, that is, the control of flow, pressure and direction of flow, applies equally as well to a rolling mill in a steel-works or a winch drive on a trawler.

The Hit and Miss Approach

The only alternative to a logical troubleshooting method is the 'hit and miss' approach, where units are changed at random until the failed component is located. Eventually the problem may be found, but on all but the simplest of systems this method proves to be expensive in terms of time and money. It is usually the case that a large number of perfectly servicable units are changed before the right one is found.



As with all troubleshooting techniques, knowledge of components and their function in a system is vitally important. It is probably fair to say that when all the components of a hydraulic system have been identified, their function determined and the operation of the system as a whole understood, the troubleshooter has gone 51% of the way towards finding the problem. It is important therefore, that to make use of this book effectively, a good understanding of the basic principles of hydraulics together with a knowledge of the operation and application of hydraulic components should first be obtained.

Shutting Down Machines

Whenever servicing work is carried out on a hydraulic system, the overriding consideration should be one of safety; to the maintenance engineer himself, his colleagues and the machine operators. Although safe working practices rely largely on common sense, it is very easy to overlook a potential hazard in the stress of a breakdown situation. Maintenance personnel should therefore discipline themselves to go through a set procedure before commencing any work on a hydraulic system. Because hydraulic fluid is only slightly compressible when compared with gas, only a relatively small amount of expansion has to take place to release the static pressure. However, where compressed gas can be present in a hydraulic system, either through ineffective bleeding, or where an

accumulator is fitted, extra care must be taken to release the pressure gradually.

Safety procedure for shutting down machines

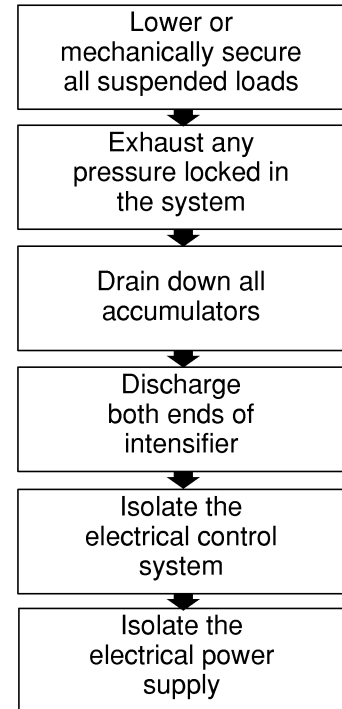

Line Service

When adopting service or troubleshooting procedures, it is useful to define three distinct areas similar to those used in the armed forces, that is, first, second and third line service.

First Line

Service or troubleshooting carried out on the machine itself and resulting in the failed component being identified and repaired whilst still in situ, or replaced.

Second Line

Investigation and repair of a failed or suspect component away from the machine, possibly in a user's own workshop

Third Line

Investigation, overhaul and retest of a component carried out at the maker's factory or service depot.

It should be the responsibility of the maintenance manager to decide where the dividing line is drawn between each area for his particular equipment.

First Line Service

Repair on site.

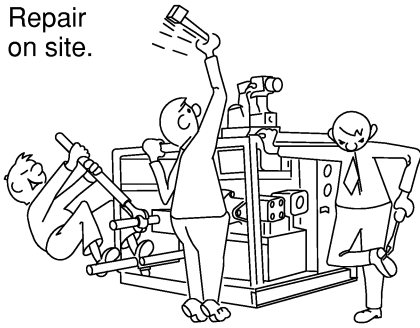

Second Line Service

Repair in workshop.

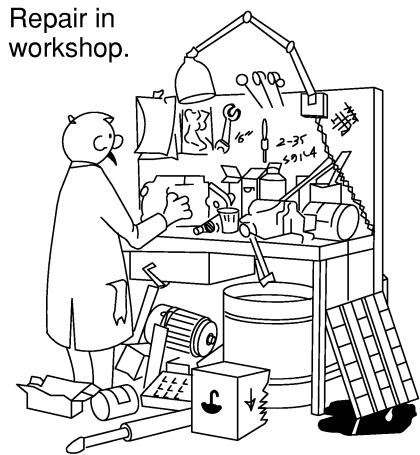

Third Line Service

Manufacturers repair service

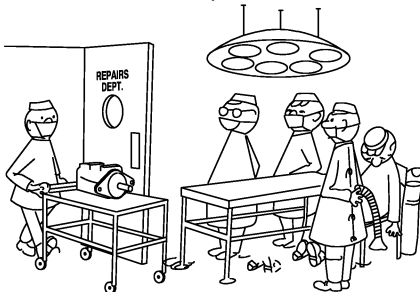

For example, if a pump fails on a system it may be possible to repair the unit whilst still on the machine i.e. first line service. In another case it may be necessary to replace the unit with a new one sending the failed pump to a workshop or second line area where a decision can be made either to repair, return to manufacturer (third line) or if the unit has reached the end of its useful life, to scrap it. Obviously several factors will affect this decision, such as spares availability, time factors, etc. Wherever the line is drawn, the procedure should be clearly defined for the benefit of maintenance personnel.

This book is confined to the first line area i.e. working from a fault to the failed component. Second line service information can be found in other Vickers publications together with details of specialist test equipment.

Checking Faults

The troubleshooting procedure in this book will endeavor to answer the following questions:

What do I check?

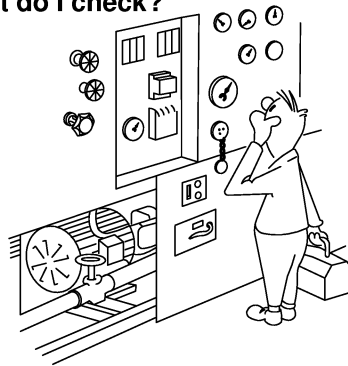

Where do I check?

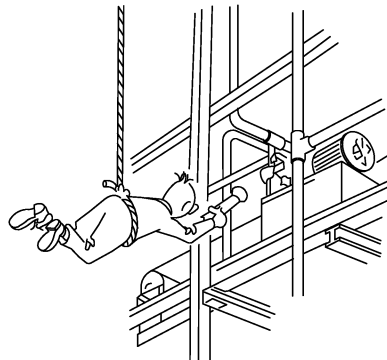

What do I check with?

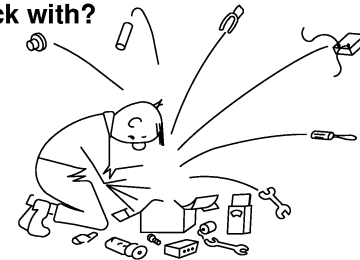

What do I expect to read?

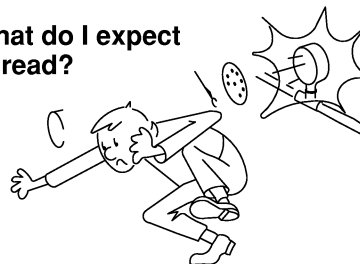

What do I check?

Which things can be measured in a hydraulic system that will indicate where the problem lies? A doctor will very often check a patient's heartbeat and temperature when making a diagnosis, to what do these correspond in a hydraulic system?

What do I check with?

Knowing what to check, it is then necessary to determine any special instruments or equipment that will be required (corresponding to the doctor's stethoscope and thermometer).

Where do I check?

Whereabouts in a hydraulic system is it necessary to carry out the checks and which should be done first? As mentioned, a doctor will very often check a patient's heartbeat i.e. the human pump; should the hydraulic pump be check first?

What do I expect to read?

Having taken a measurement at a certain point in a system, it is obviously necessary to know what the correct reading should be in order to draw conclusions if the reading is any different from normal. Again, a doctor knows that the body temperature should be 37°C so if there is any variation, a diagnosis can be made.

What do I check?

A hydraulic system is a means of transmitting and controlling power. Mechanical power is a function of force multiplied by distance moved per second or force \times velocity. If a hydraulic actuator is considered as a device to convert hydraulic power to mechanical power, then the force (or torque) exerted by the actuator is governed by the applied *pressure* and the velocity (or angular velocity) is governed by the *flow* rate. It follows, therefore, that *flow* and *pressure* are two basic elements of a hydraulic system that control the power output. In engineering terms, velocity usually implies both speed and direction, speed, as discussed being controlled by flow rate and the direction of the actuator movement being controlled by the *direction* of flow.

The three factors therefore that transmit and control power in a hydraulic system are:

- Flow*
- Pressure*
- and *Direction* of flow

and it follows that in order to assess the performance of a hydraulic system one or more of these factors will have to be checked. In order to decide which, it is necessary to obtain the full facts of the problem.

Very often when a problem is reported on a machine, it is described in vague terms such as "lack of power". As previously mentioned, power is a function of both force and velocity and it is necessary to define the problem in terms of one or the other. In practice, relevant questions must be asked in order to determine exactly what the problem is i.e. when lack of power is reported does it mean that the actuator is moving too slowly, or is it not giving the required force or torque?

Having defined the problem as one of *Speed, Force (Torque) or Direction* it is now possible to define the hydraulic problem as one of *Flow, Pressure or Direction*.

Although the troubleshooting procedure is based upon checking flow, pressure and direction, there are other aspects of a system which can be measured both as an aid to locating a failed component and also to determine the reasons for a component failure. such properties are:

- *Negative pressure (vacuum)*, especially in the area of the pump inlet to check for problems in the suction line.
- *Temperature*, generally when one component or part of a system is hotter than the rest, it is a good indication that flow is taking place.
- *Noise*, when checked on a regular or routine basis is a good indicator of pump condition.
- *Contamination level*, when repeated problems occur the cleanliness of the fluid should always be checked to determine the cause of the failures.

Instrumentation Principles and Measuring Instruments

What do I check with?

When an electrician checks an electrical circuit, he usually has available a meter that will measure electric current and voltage. In a hydraulic system the voltage corresponds to the pressure, and is usually measured with a pressure gauge, the current corresponds to the flow and is usually measured with a flow meter. Although the electricians meter will measure positive or negative voltage, if the hydraulic engineer wishes to measure a negative pressure i.e. vacuum, then a separate instrument is required, namely a vacuum gauge.

Apart from the basic requirements of a pressure gauge, vacuum gauge and flow meter, there are several other instruments that can prove useful to the hydraulic engineer i.e.:

- *Pressure Transducer and Recorder*. If the pressure in a system needs to be measured to an accuracy greater than that which can be obtained with a pressure gauge, or if transient pressure peaks or shocks need to be measured, then a pressure transducer can be used which produces a varying voltage according to the pressure applied.
- *Measuring Jar and Stopwatch*. For measuring very small flows such as leakage, a graduated jar and watch may be used. This can very often give a more accurate reading than a flow meter working at the bottom of its range.

- *Temperature Gauge or Thermometer.*

To measure the general system temperature a temperature gauge can be immersed in the fluid reservoir (sometimes incorporated with the level gauge). Very often the temperature gauge incorporates a switch to give a warning if the fluid temperature is too low or too high.

- *Thermocouple.*

Temperature can be measured locally in a system by means of a thermocouple. If one part of a system is very much hotter than the rest, it is a good indication that power is being wasted (such as a leakage point).

- *Noise Meter.*

Excessive noise is again a good indication of a fault in a system especially the pump. In the middle of a noisy factory it may be difficult to judge whether a pump is more noisy than usual, so a noise meter enables a comparison to be made between a suspect pump and a new pump.

- *Particle Counter.*

The condition of the system fluid from a contamination point of view is obviously a major factor in the life and performance of a system. In trying to determine the reasons for a component failure it may be necessary therefore to measure the cleanliness of the fluid.

Although equipment may not be available on site to check the fluid, such a service is offered by most of the major fluid suppliers and filter manufacturers.

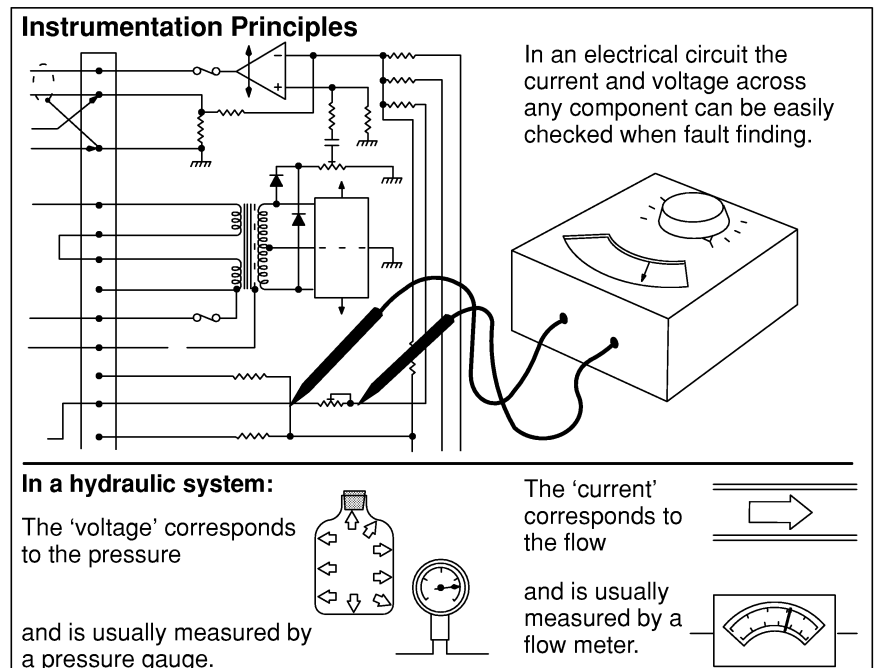

Measuring Instruments

System pressure is usually measured with a pressure gauge.

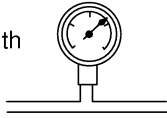

For very accurate measurement of pressure or for measuring transient pressure shocks, a pressure transducer and recorder may be used.

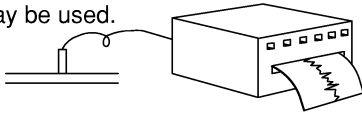

Flow is usually measured by a flow meter which can be of several different types.

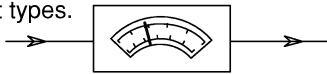

For very small flows (e.g. leakage) a measuring jar and stopwatch may be used.

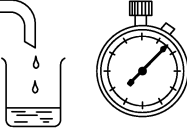

Temperature is usually measured with a thermometer or temperature gauge.

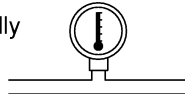

For certain applications a thermocouple and electrical meter is used to measure temperature.

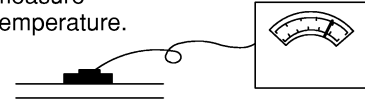

Noise can be measured with a noise meter.

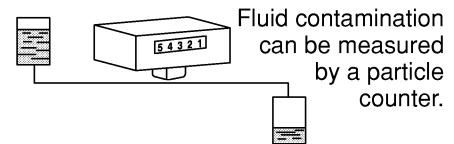
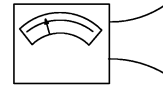

Considering the two basic requirements of pressure/vacuum gauges and flow meters, thought should now be given on how they are to be connected into the system, bearing in mind the type of instrument concerned.

Pressure Gauges

Pressure gauges are usually of the Bourdon Tube type consisting of a curved tube attached to a pointer. When pressure is applied to the curved tube, it tends to straighten out, exactly as a garden hose does when the tap is turned on. As the tube straightens, the pointer is moved around the dial, indicating the applied pressure. Being a delicate instrument, it is necessary to protect the gauge as much as possible from pressure shocks in the system. Usually some form of snubber arrangement is fitted to the stem of the gauge, and the complete case may be filled with glycerine to damp down vibrations.

Pressure gauges are available in several different ranges and obviously a gauge must be chosen to suit the expected pressure reading (if in doubt as to what the pressure is likely to be, start with a high pressure gauge first). Most pressure gauges however tend to be more accurate around half scale deflection i.e. a 0 – 100 bar gauge would be most accurate around pressures of 50 bar.

Pressure Gauge Installation

There are several ways of connecting a pressure gauge into a system as follows:

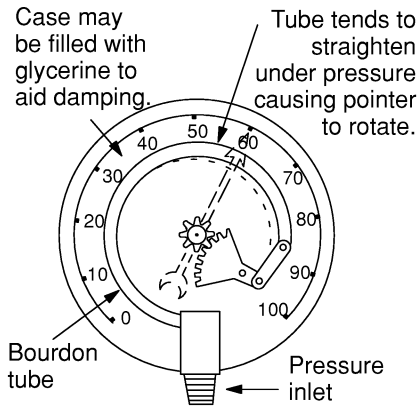

Snubber Arrangements

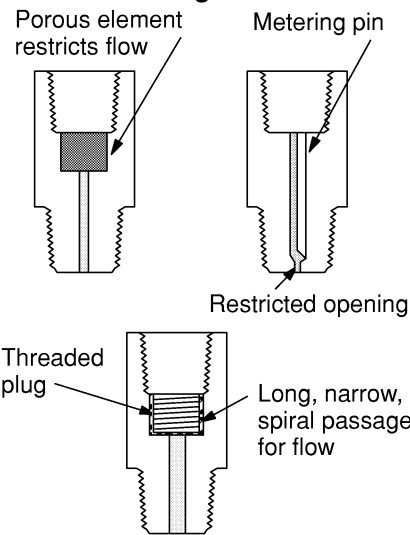

1. The gauge can be directly connected into the pipework by means of a 'tee' piece. Obviously, the gauge will be subject to all the pressure shocks in the

system so over a period of time the accuracy will inevitably drop off.

2. The gauge can be installed with an isolating valve so that the valve is only opened when a pressure reading needs to be taken and the gauge is normally isolated from shocks in the system.

3. A venting isolation valve may also be used normally of the 'push-to-read' or 'twist-to-read' type which both isolates the gauge from the system and also vents the gauge to tank when the button is released.

4. A multi-station isolating valve allows the pressure to be read at six different points in the system using only one pressure gauge. The valve is also usually of the push-to-read type, venting the gauge when the button is released.

5. Most hydraulic units are provided with gauge points in inlet and outlet ports usually a screwed plug. If the system designer has not allowed for a gauge to be permanently installed in a part of the system, it is usually possible to connect one in without having to disturb pipework, etc., provided the gauge points can be identified.

6. Quick release, self sealing test points can be provided around the system (or even connected into unit gauge points) allowing the maintenance engineer to check pressure in the system with a portable gauge kept in his toolbox, fitted with the appropriate male probe. (By connecting the male probe to the test point without a pressure gauge, they can also be used for bleeding air from the system.)

Pressure Gauge Installation

1. Pressure gauge permanently installed in pipe-work.

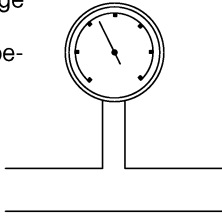

2. Pressure gauge installed with shut-off valve.

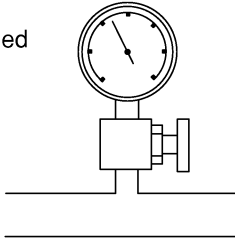

3. Pressure gauge installed with venting isolation valve.

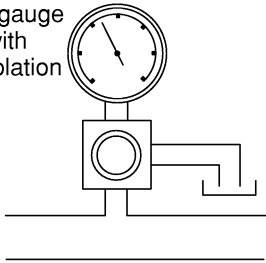

4. Pressure gauge installed with multi-point selector valve.

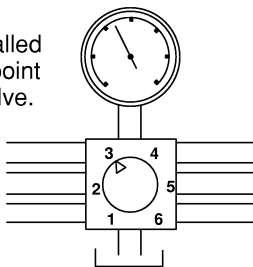

5. Pressure gauge plugged into unit gauge point.

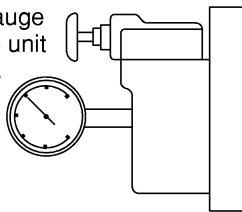

6. Pressure gauge plugged into system test point.

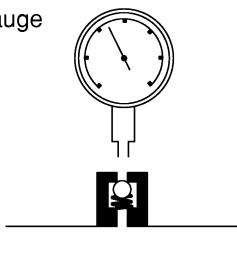

Flow meters are available of several different types such as the float type or turbine type. In addition, test units are available which combine flow meter, pressure gauge and temperature gauge in one portable unit. In practice, flow meters are rarely connected into a system permanently since flow setting in a system is usually accomplished by measuring the speed of an actuator. When it is necessary to check flow in a system, however, careful consideration should be given to the positioning of the flow meter in the system.

Float Type

Flow through tube causes indicator to rise in tube

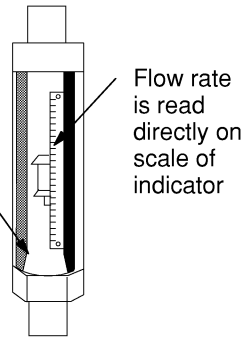

3. An electrical device will be connected to the sensor to convert the pulses to flow rate information

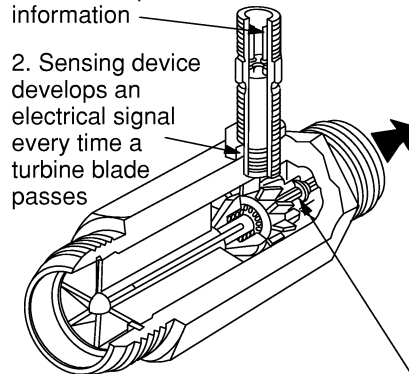

2. Sensing device develops an electrical signal every time a turbine blade passes

1. Flow causes turbine to spin at rate determined by the rate of flow

Hydraulic Test Unit

A hydraulic test unit combines...

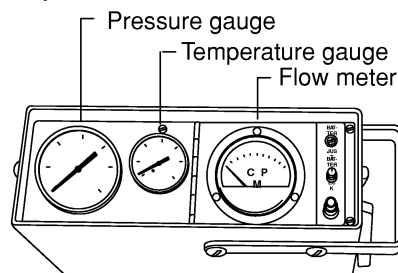

...in one unit

Flow Meter Installation

Flow meters may be installed in a hydraulic system to check while the machine is operating normally (on-line) or while the machine is shut down for maintenance purposes (off-line).

On-line

Figure (A) illustrates a flow meter installed in the main flow line from the pump. By incorporating two 3-way valves in the line, a flow meter can be connected to the system and the 3-way valves selected to divert flow through the meter. The meter used must obviously be capable of withstanding the full system pressure and flow. The meter reading will indicate the flow available to the system, but if the reading is less than specification it is not immediately apparent whether the pump is giving less flow than required or the relief valve is leaking a proportion of the pump flow to tank. If a problem is found however, the list of possible causes has been narrowed down to two units, and a check on the tank return line from the relief valve should then confirm which of the two units is at fault.

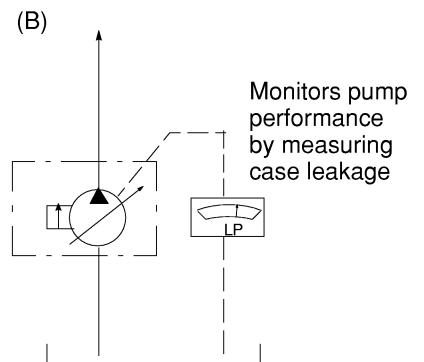
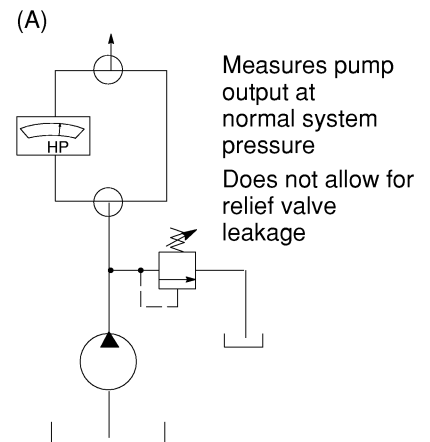

Flow Meters

In the case of a variable pump, the pump output flow will only be that actually required by the system at any time. A good indication of pump performance however, can be obtained by measuring the internal leakage in the pump, i.e. measuring the case drain flow as indicated in Figure (B). A certain amount of case leakage is inherent on brand new pumps (caused by design clearances, lubrication drilling etc.) so it will be necessary to compare the leakage actually measured with that for a pump within full specification. When measuring case leakage it is important that it is done under steady state conditions, i.e. with the pump delivering a constant volume. The flow meter required will only have to withstand pump case pressure (normally around 0.3 bar) and very low flows so in fact a measuring jar and stopwatch may be used. It is important however that the drain line is NEVER allowed to be blocked off.

Figure (C) illustrates a typical off-line arrangement. The addition of two shutoff valves in the system allows the system itself to be isolated and the pump flow

Off-line

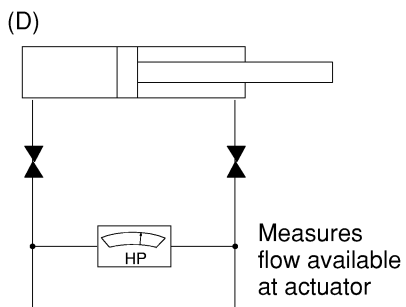
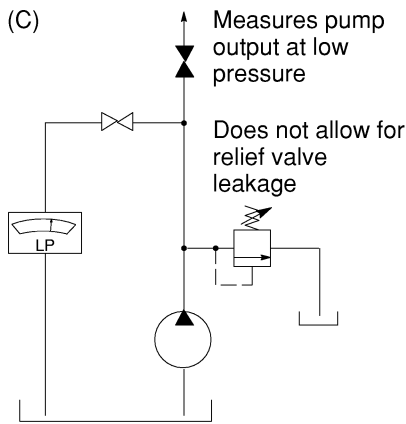

diverted through the flow meter. Again a low pressure meter can be used since the pump flow is measured at low pressure although this may not give a true indication of the pump outlet at normal working pressure. As mentioned previously, a flow deficiency could be caused by low pump output or relief valve leakage so a further check will be required if this is the case. It is possible to incorporate a restrictor in the flow meter line in order to develop pressure, in which case of course, a high pressure meter will be required.

If the output from the pump unit proves to be satisfactory, it may be necessary to connect flow meter into other areas of the system. Again the addition of isolating valves as illustrated in Figure (D) considerably simplifies the operation.

CAUTION
 Whenever a flow meter is connected into a system, it is vital to ensure that the pump always has direct access to the relief valve, and the relief valve tank line is never allowed to be blocked off or unduly restricted.

Where do I check and what do I expect to read?

When considering failures in a hydraulic system there can be two alternative starting points namely:

- **Machine Malfunction** – where a fault occurs in a hydraulic system causing a malfunction on the machine itself i.e. an actuator fails to operate correctly.
- **System Malfunction** – where a fault occurs in the hydraulic system without necessarily affecting the machine performance in the short term, e.g. excessive leakage, temperature etc.

The two can of course occur together. For example, a pump failure would result in the machine failing to operate correctly and would most likely be accompanied by an increase in noise level. Experience has shown that it is usually better to start at the fundamental problem and work through the checking procedure, using symptoms such as heat, noise, leakage etc, as clues.

Again, common sense must prevail when working through this procedure, as some symptoms may point straight to the problem area. A fountain of oil gushing from a valve points immediately to the problem area, but some symptoms may not be so obvious. When a unit leaks flow from high to low, pressure heat is usually generated locally in that part of the system which may not be immediately obvious.

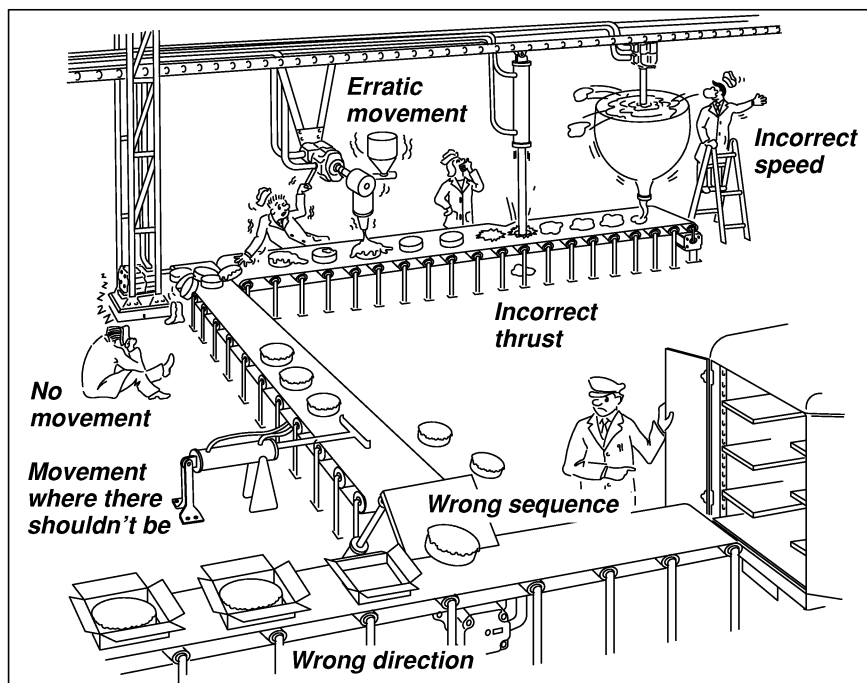

Whichever the starting point, certain questions should be answered before proceeding. When a problem is reported, it is important to gather as many facts together as possible. It could be that the same problem occurred six months ago and is recorded somewhere on a log sheet or record card in which case a good deal of time can be saved. It should be ascertained whether any recent maintenance work or adjustments have been made to the system. The exact nature of the failure should be determined, was it a sudden or gradual breakdown, which parts of the machine have been affected and which have not? It may be difficult always to get the complete story, but an effort should be made to gather as much information as possible.

The philosophy of the trouble shooting procedure is to start at the fundamental problem and determine which aspects of the hydraulic system is at fault; flow, pressure or direction. By consulting the circuit diagram, a list of possible causes can be drawn up. The next stage is to then look for the obvious. It is perhaps human nature when faced with a challenging problem to search too deeply too quickly, in the process overlooking what in hindsight appears a very obvious solution. There are certain checks that can be carried out on a hydraulic system using the human senses of sight, touch and hearing and which can be carried out very quickly. If a rigid procedure is adopted each time it will ensure that no obvious or apparently trivial problem is overlooked. In practice very many problems will be solved at this stage without having to resort to additional instrumentation.

Only if this stage fails to reveal the problem is it necessary to resort to extra pressure gauges, flow meters etc. and again a logical approach should be adopted using the algorithm charts in this book.

Machine malfunction procedure

MACHINE MALFUNCTION

Step 1

An actuator can fail to operate correctly in the following ways:
 Incorrect Speed
 Incorrect Thrust
 No Movement
 Movement in the Wrong Direction
 Erratic Movement
 Incorrect Sequence
 Creep
 Whichever fault or faults have occurred, the fundamental problem area should be defined where possible as one of FLOW, PRESSURE or DIRECTION.

Step 2

From the circuit diagram each component in the system can be identified and its function in the system determined.

Step 3

A list of units that can possibly affect the problem area can now be drawn up. e.g. A slow actuator speed can be defined as a problem of FLOW (even though this may in turn be due to lack of PRESSURE, the fundamental problem area is FLOW). A list of units that can possibly affect flow to the actuator (including the actuator itself) is drawn up bearing in mind that, for example a leaking or wrongly adjusted relief valve (i.e. a PRESSURE control valve) could affect flow to the actuator.

Step 4

The list of units can be arranged in rough order of priority based on past experience and also ease of checking.

Step 5

A preliminary check can now be carried out on each unit on the list in turn to check such things as installation, adjustment, signals etc. and also to determine if any unit exhibits abnormal symptoms such as excessive temperature, noise, vibration etc.

Step 6

If the preliminary check does not reveal the unit at fault, a more exhaustive test on each unit can be carried out using additional instrumentation but without any unit from the system.

Step 7

The instrument checks should now reveal the failed unit and a decision can be made whether to repair or replace the unit at fault.

Step 8

Before restarting the machine, thought should be given to both the cause and the consequence of the failure. If the failure was caused by contaminated or over-heated fluid, then further failures can be expected and remedial action should be taken. If a pump has broken up on a system, there is a possibility of pump debris having entered the system which should be thoroughly cleaned out before a new pump is fitted.
THINK ABOUT WHAT CAUSED THE FAILURE AND ANY CONSEQUENCES OF IT.

Machine faults

System faults

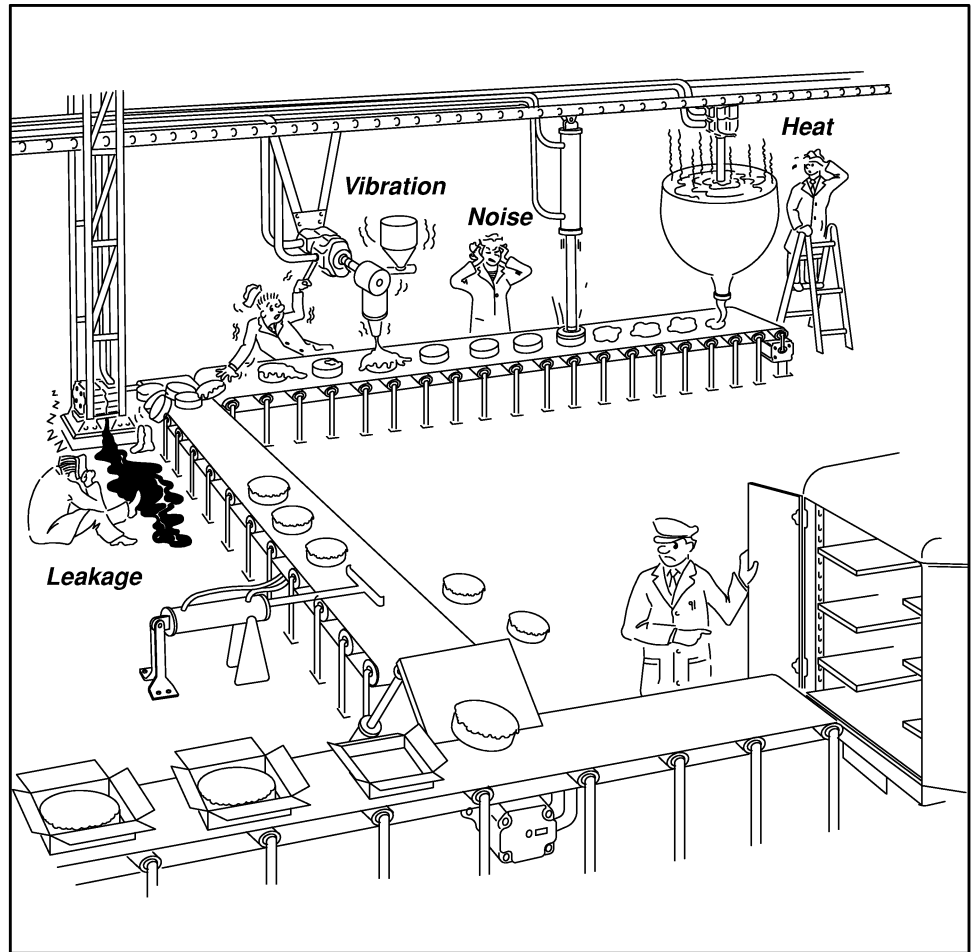
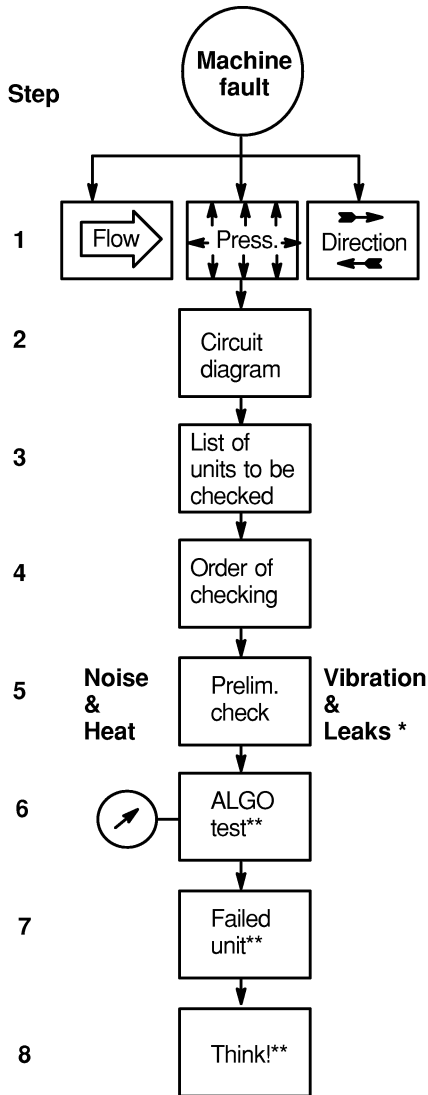

* Algo's 0.1 to 0.5

** Algo's A to L

System malfunction

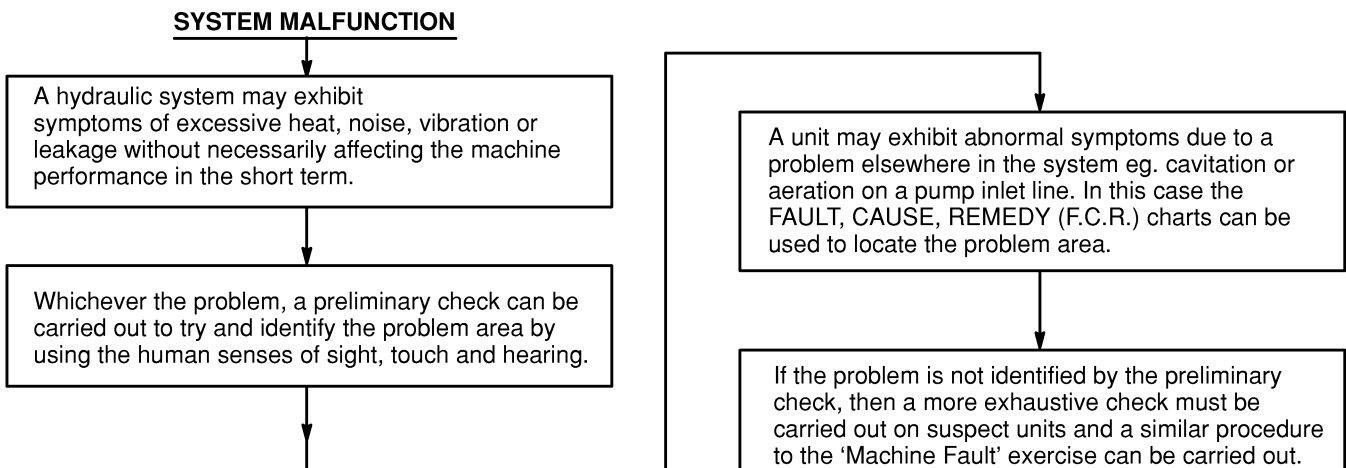

System faults

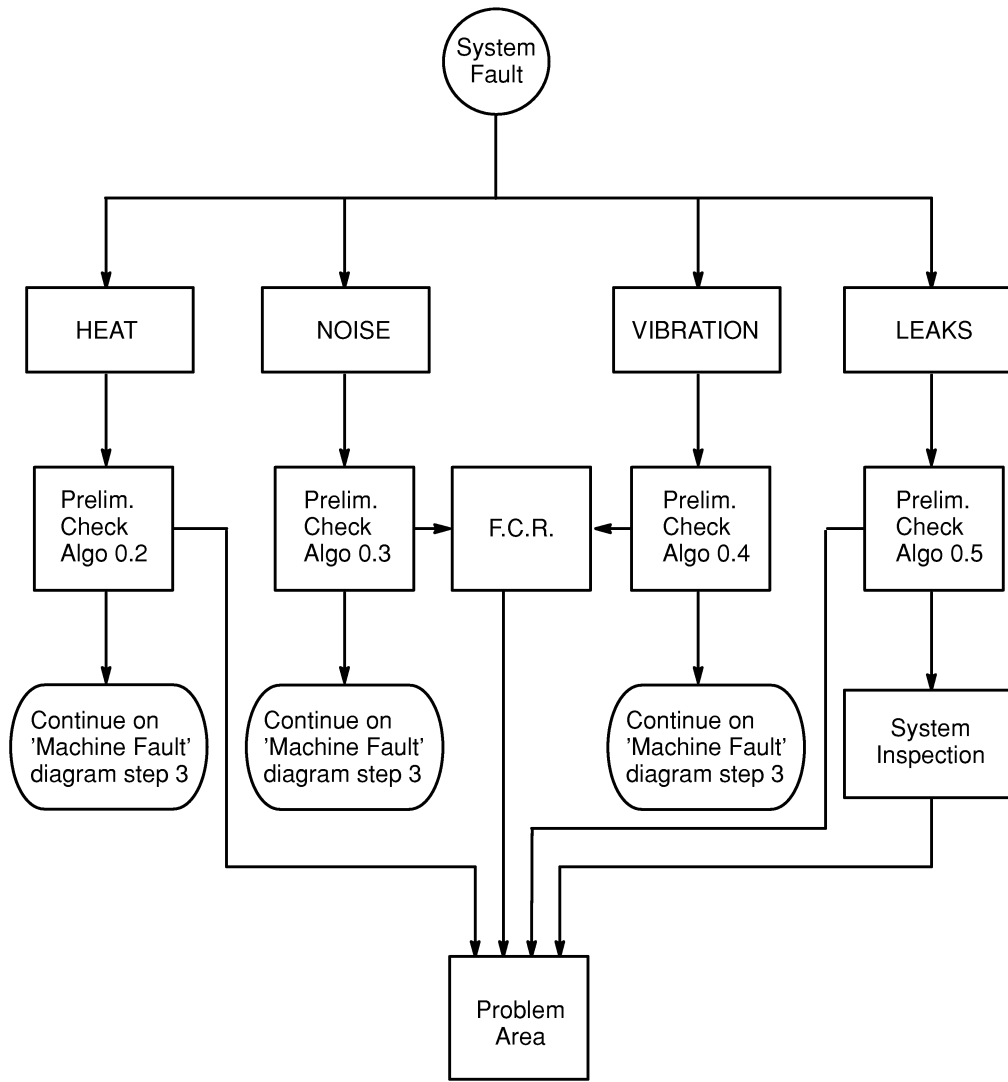

Unit Fault Preliminary Check

Algo 0.1

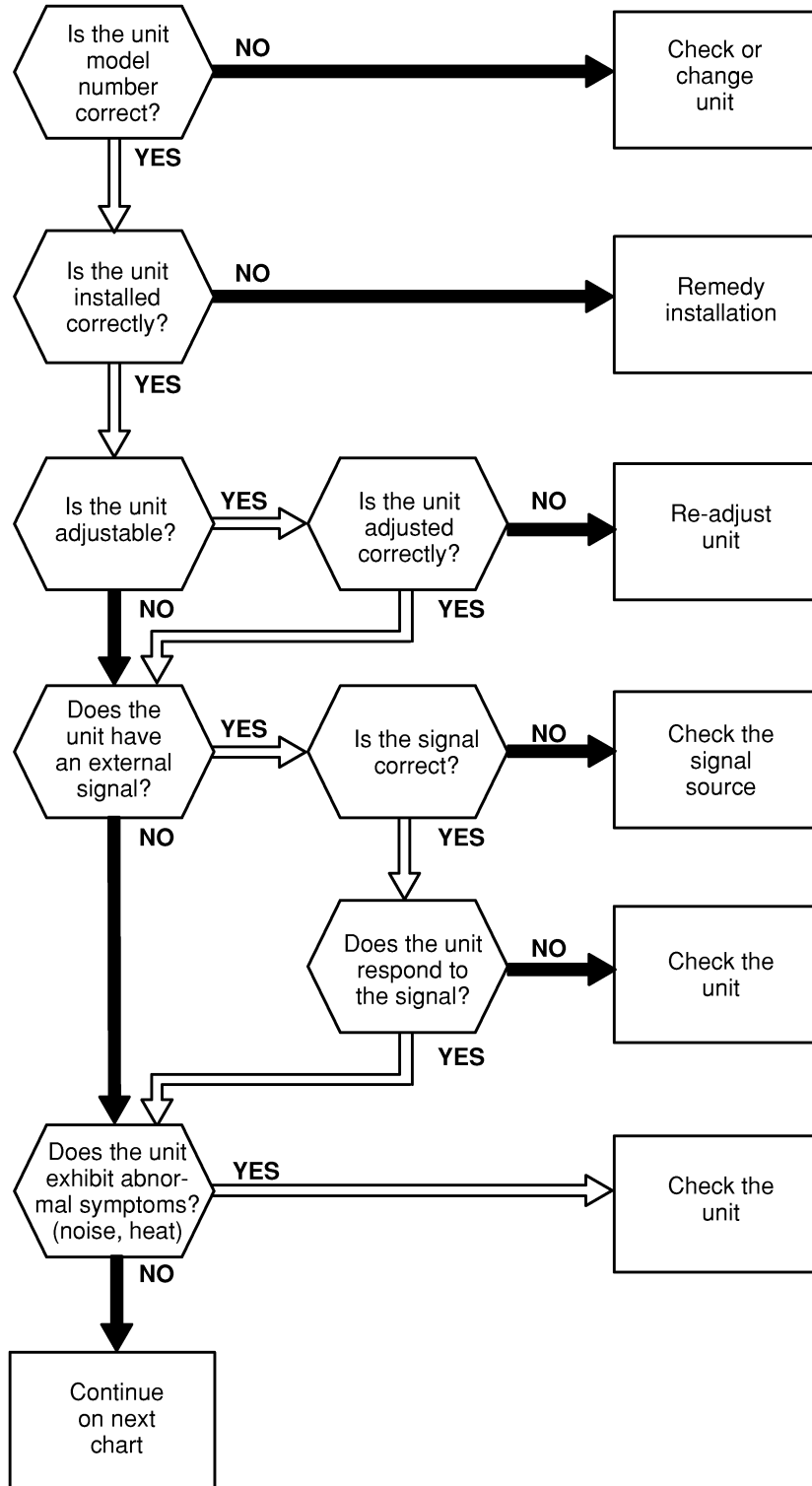

Excessive Temperature

Algo 0.2

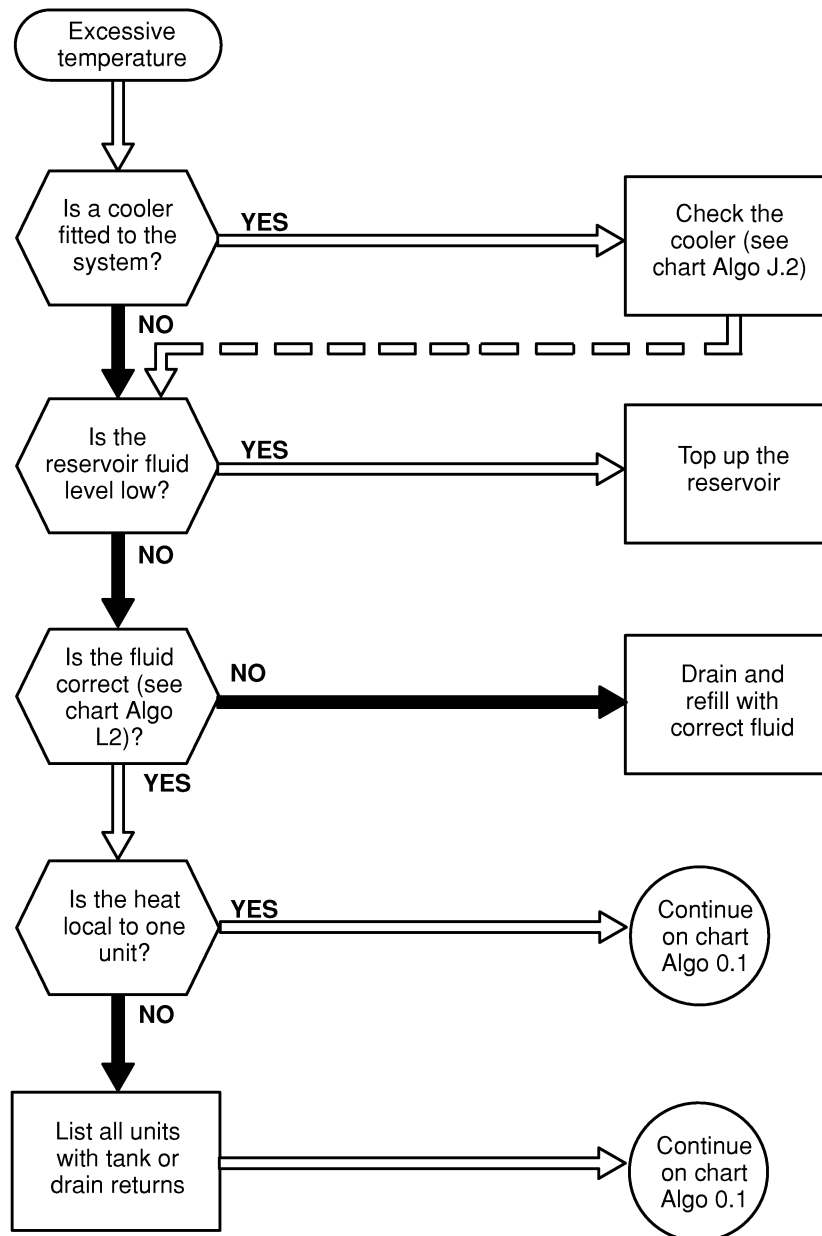

Excessive Noise

Algo 0.3

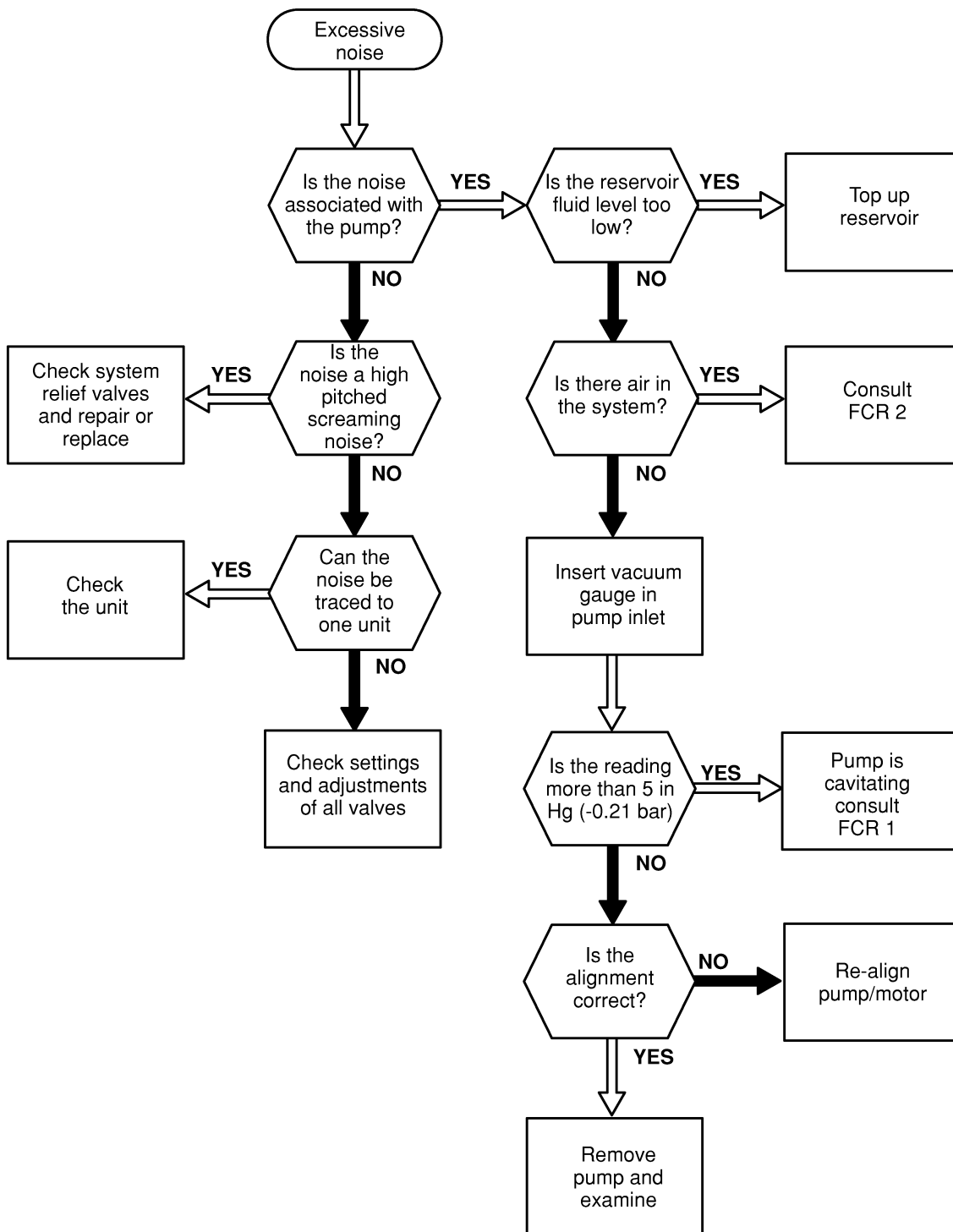

Excessive Vibration

Algo 0.4

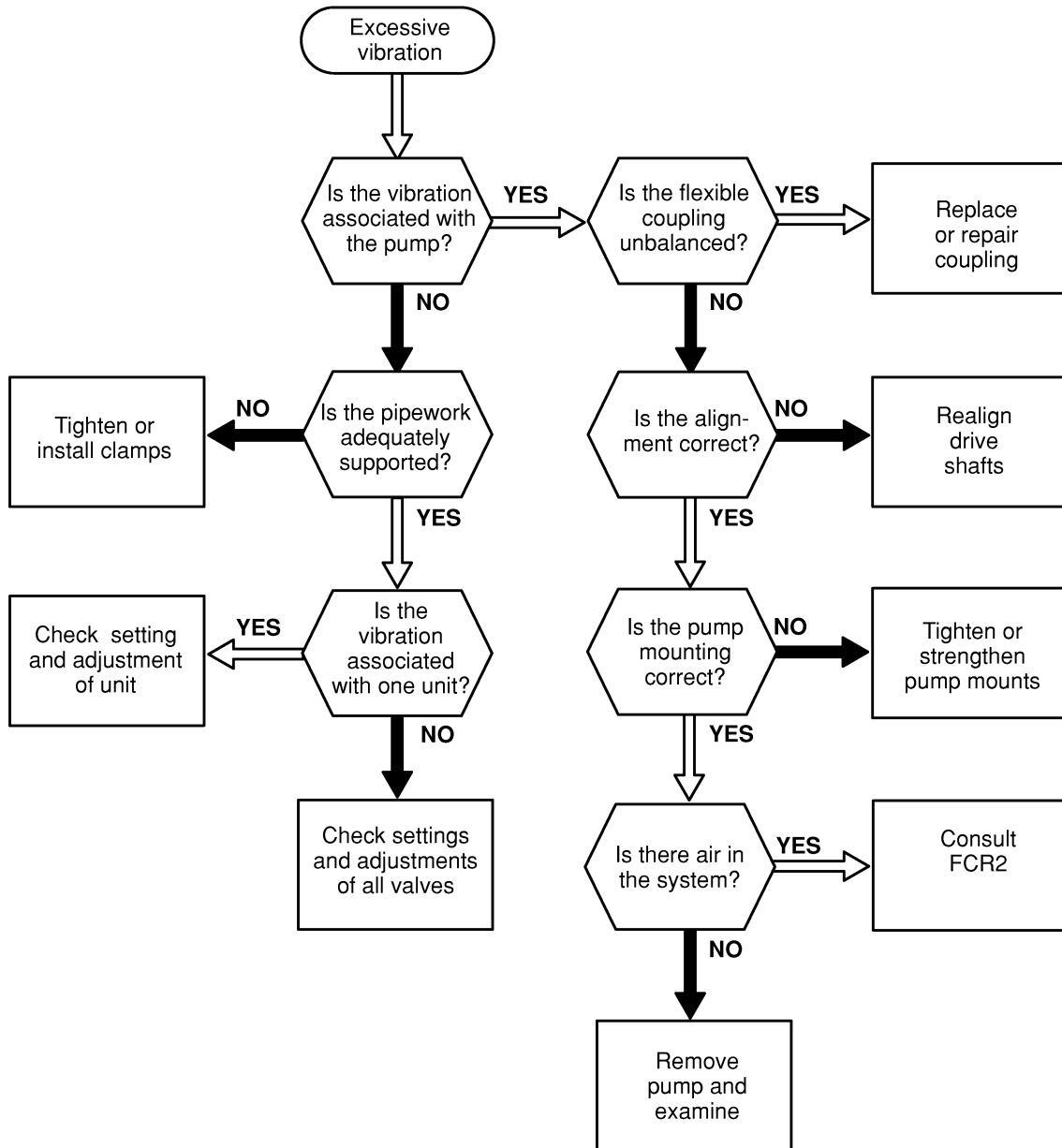

Excessive Leakage

Algo 0.5

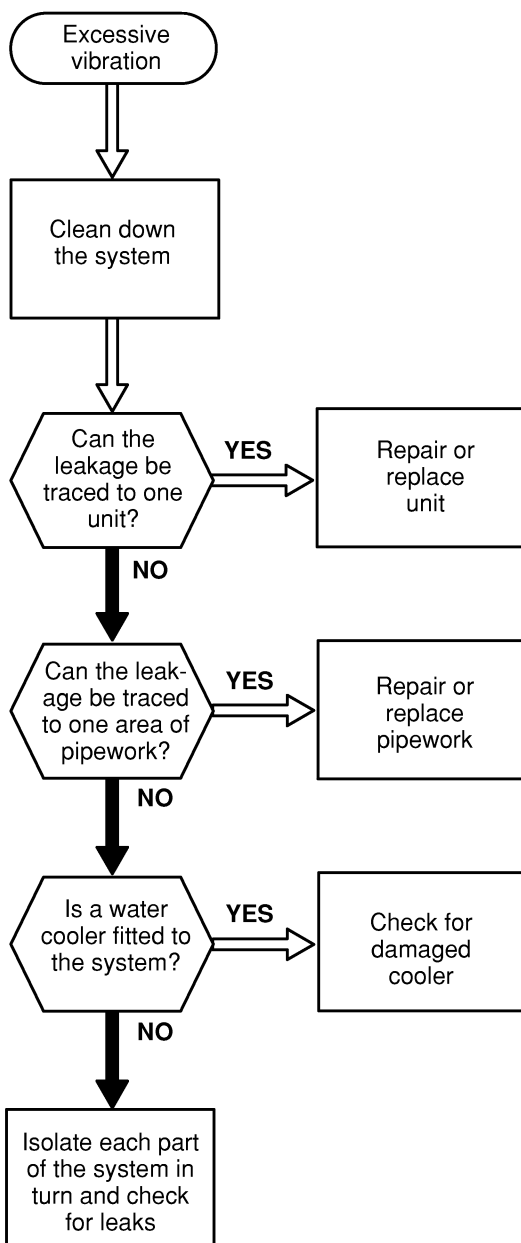

System test for gear and vane pumps

Algo A.1

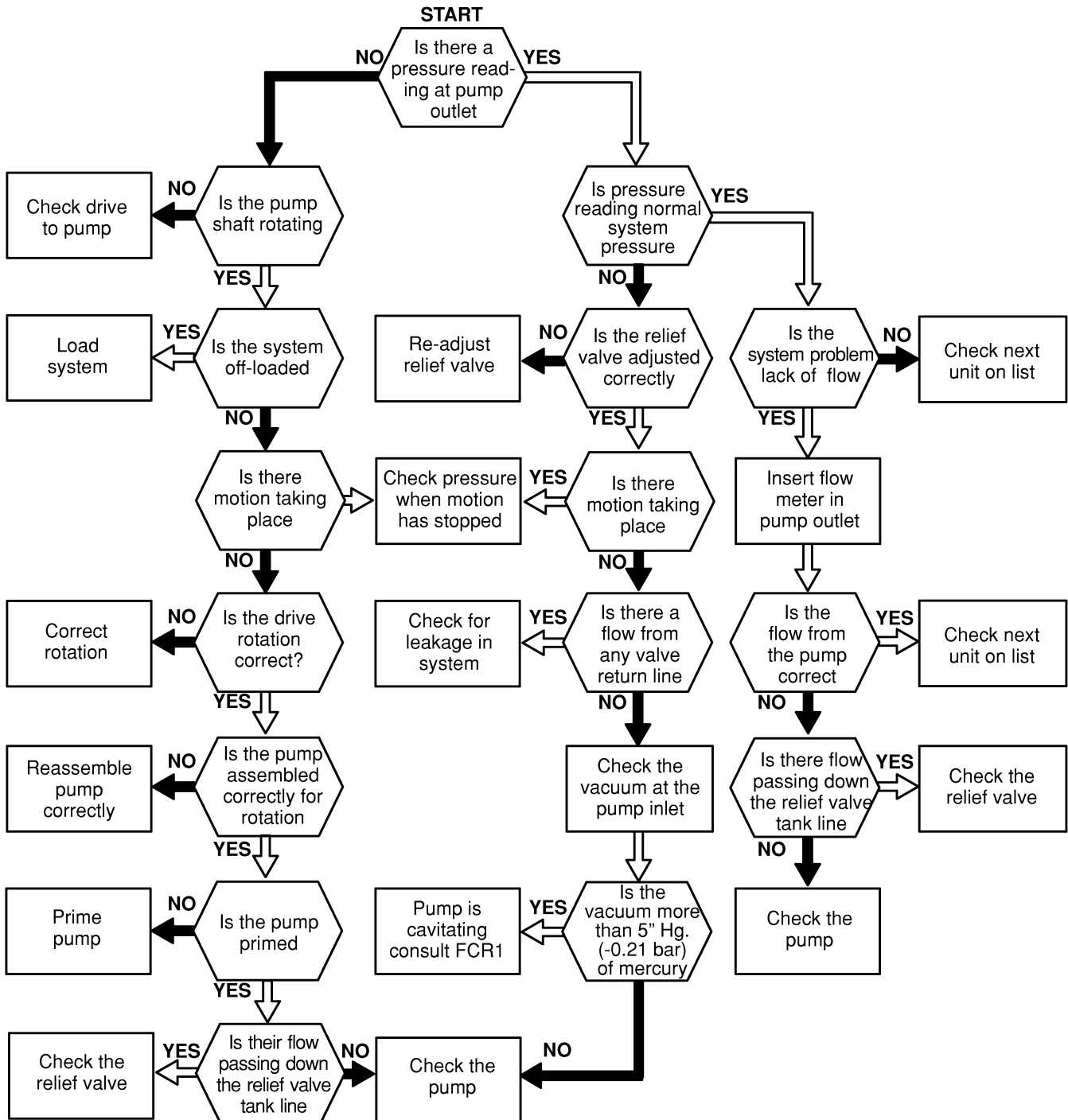
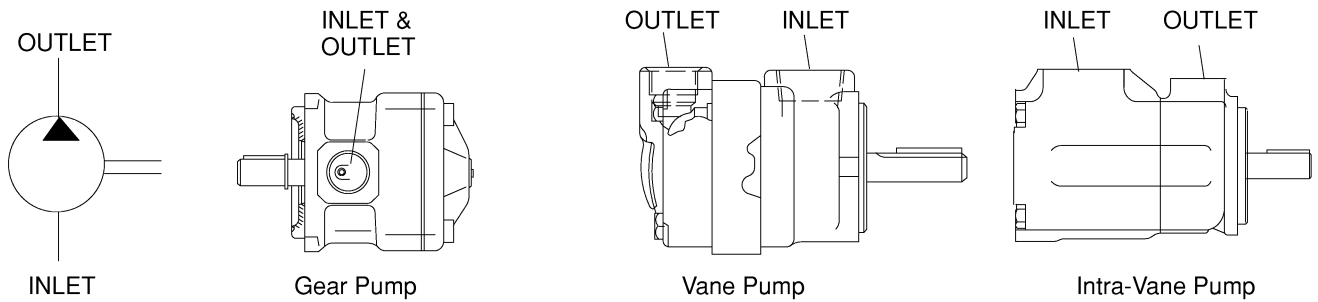

System test for piston pumps

Algo A.2

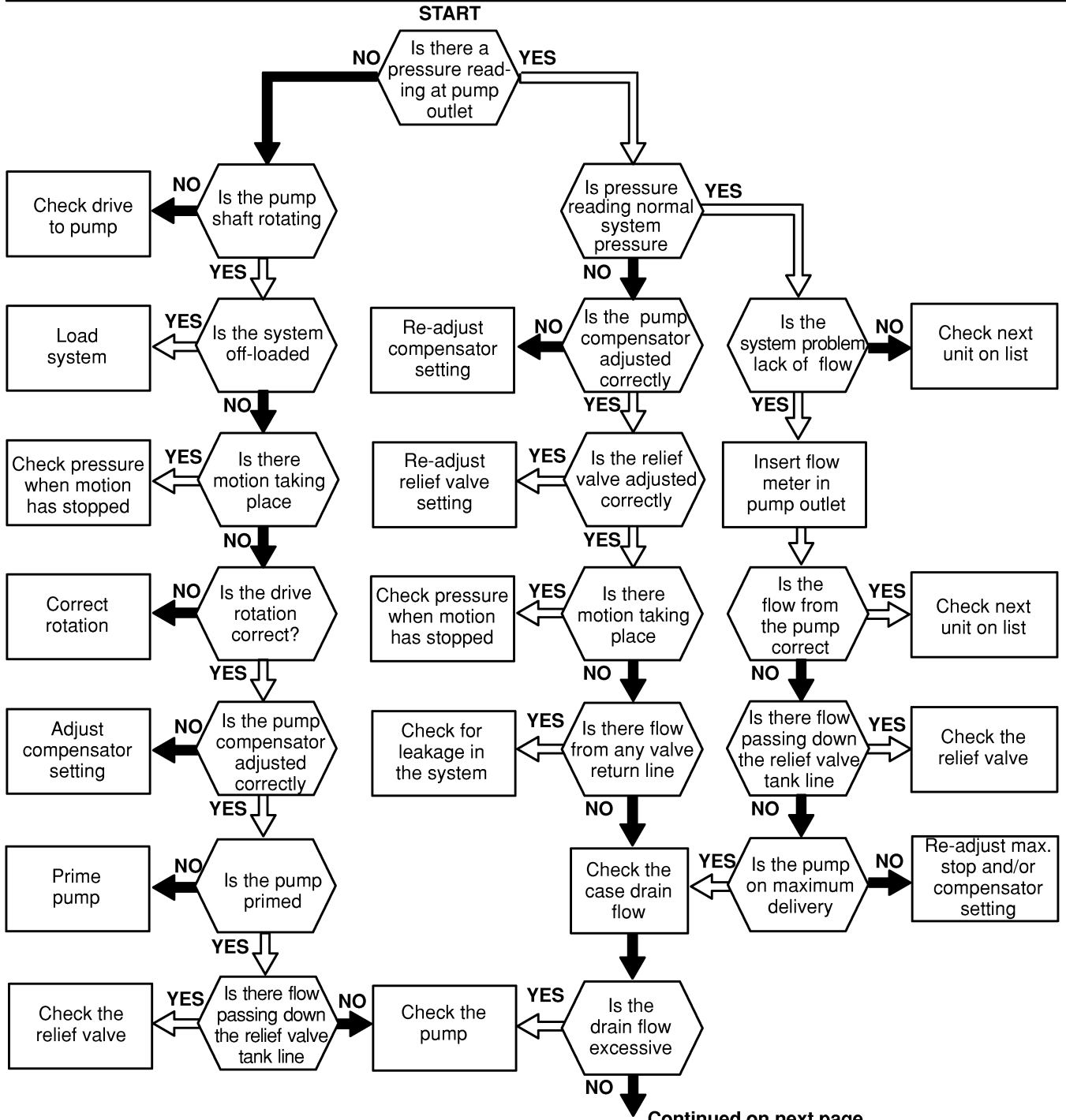
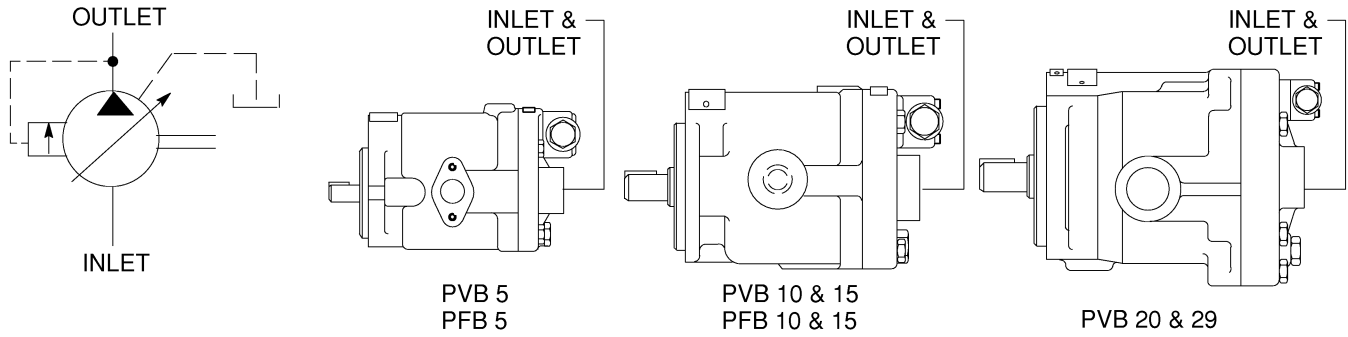

Continued on next page

System test for piston pumps (cont'd)

Algo A.2

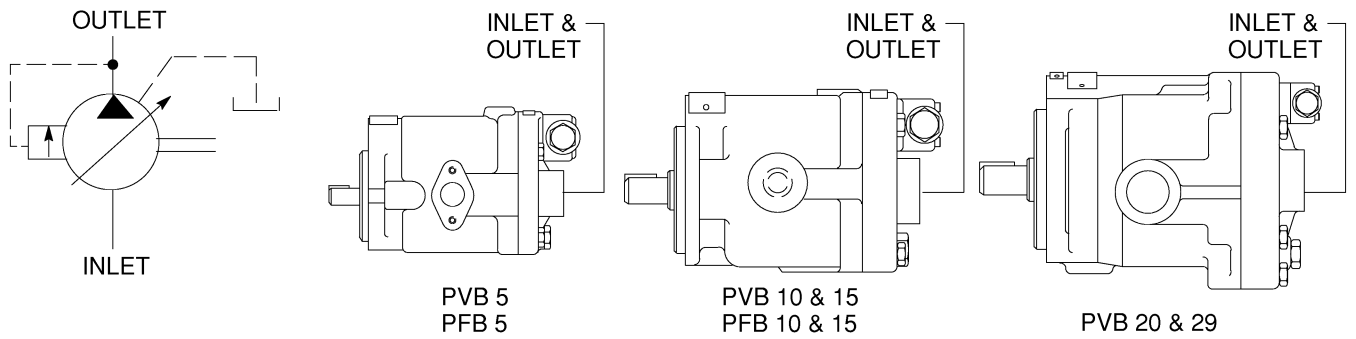

Continued from previous page

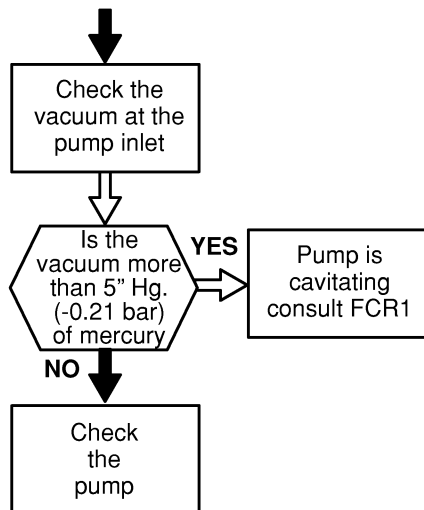

System test for pressure relief valves

Algo B.1

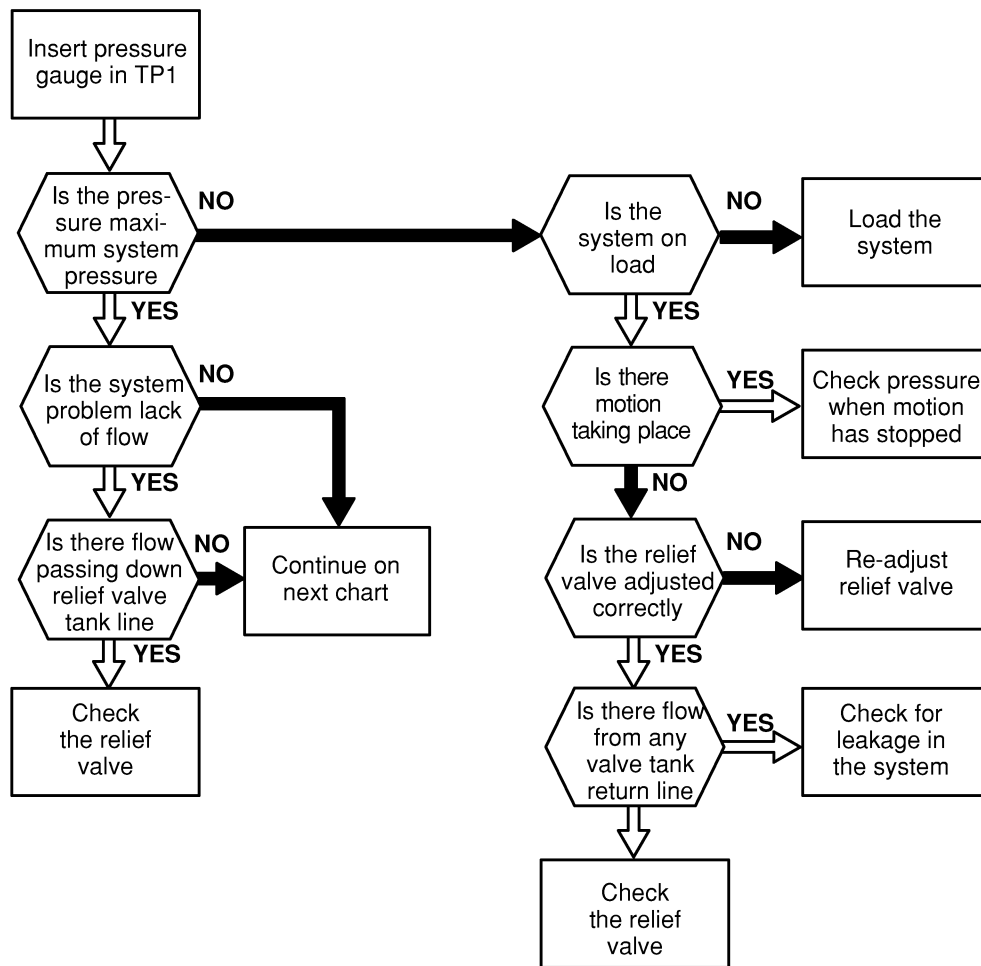
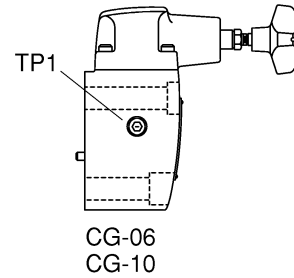
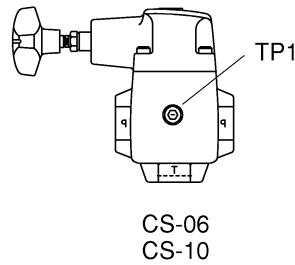
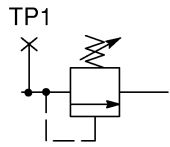

System test for sequence valves

Algo B.2

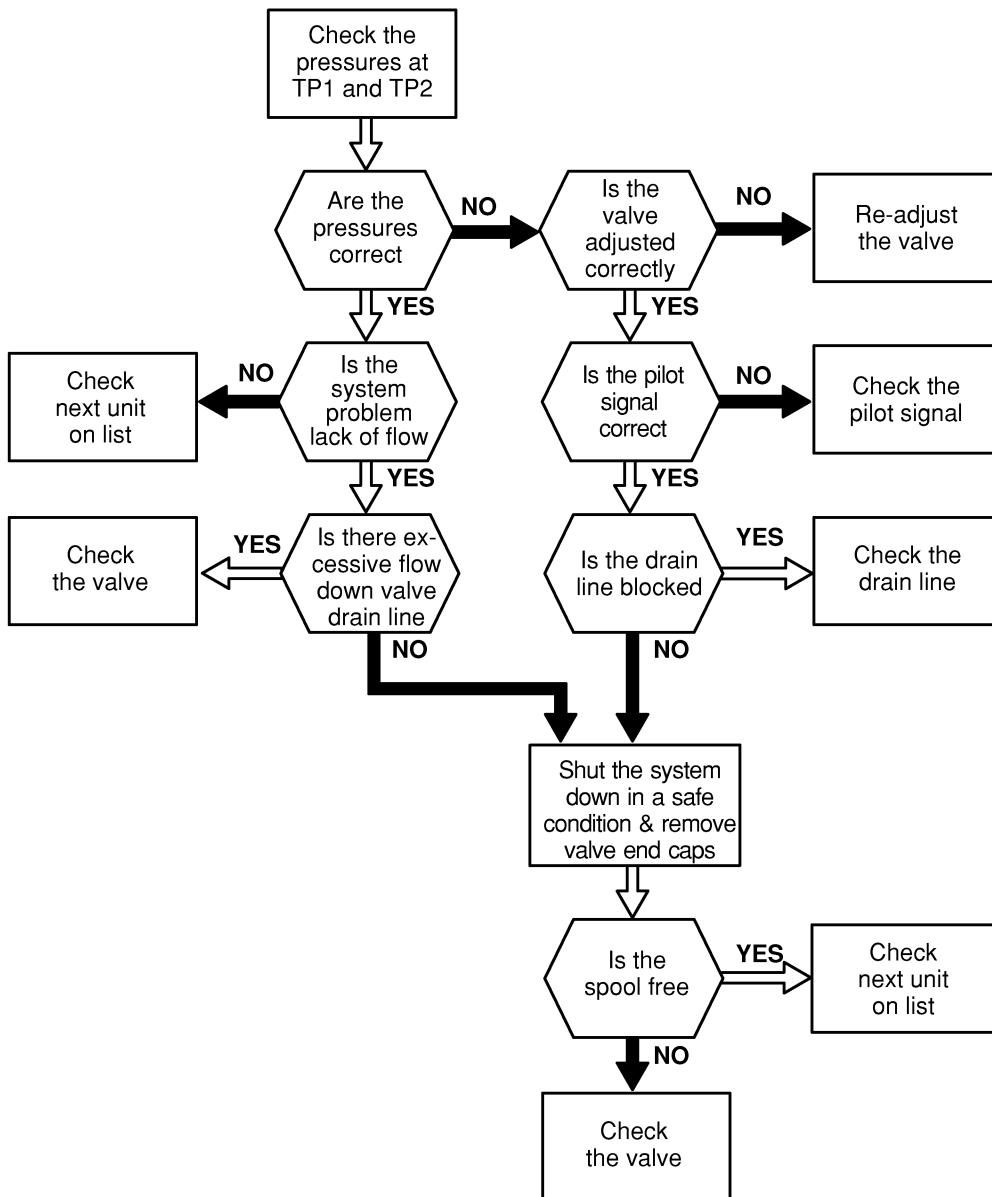
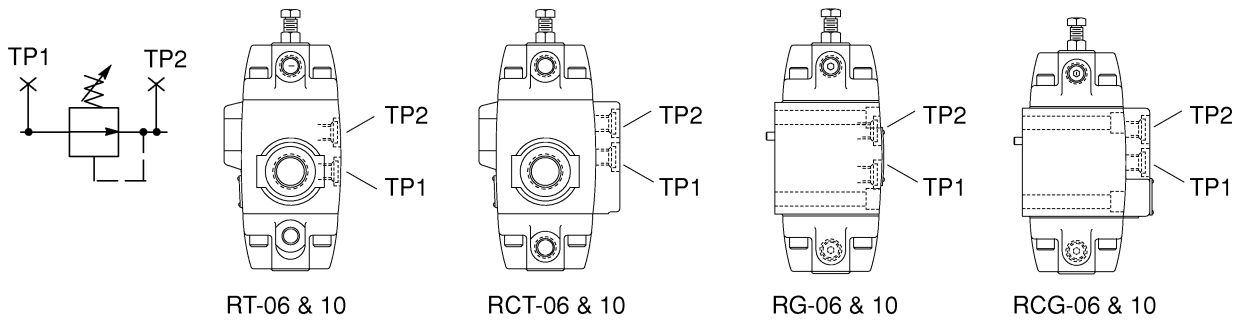

System test for pressure reducing valves

Algo B.3

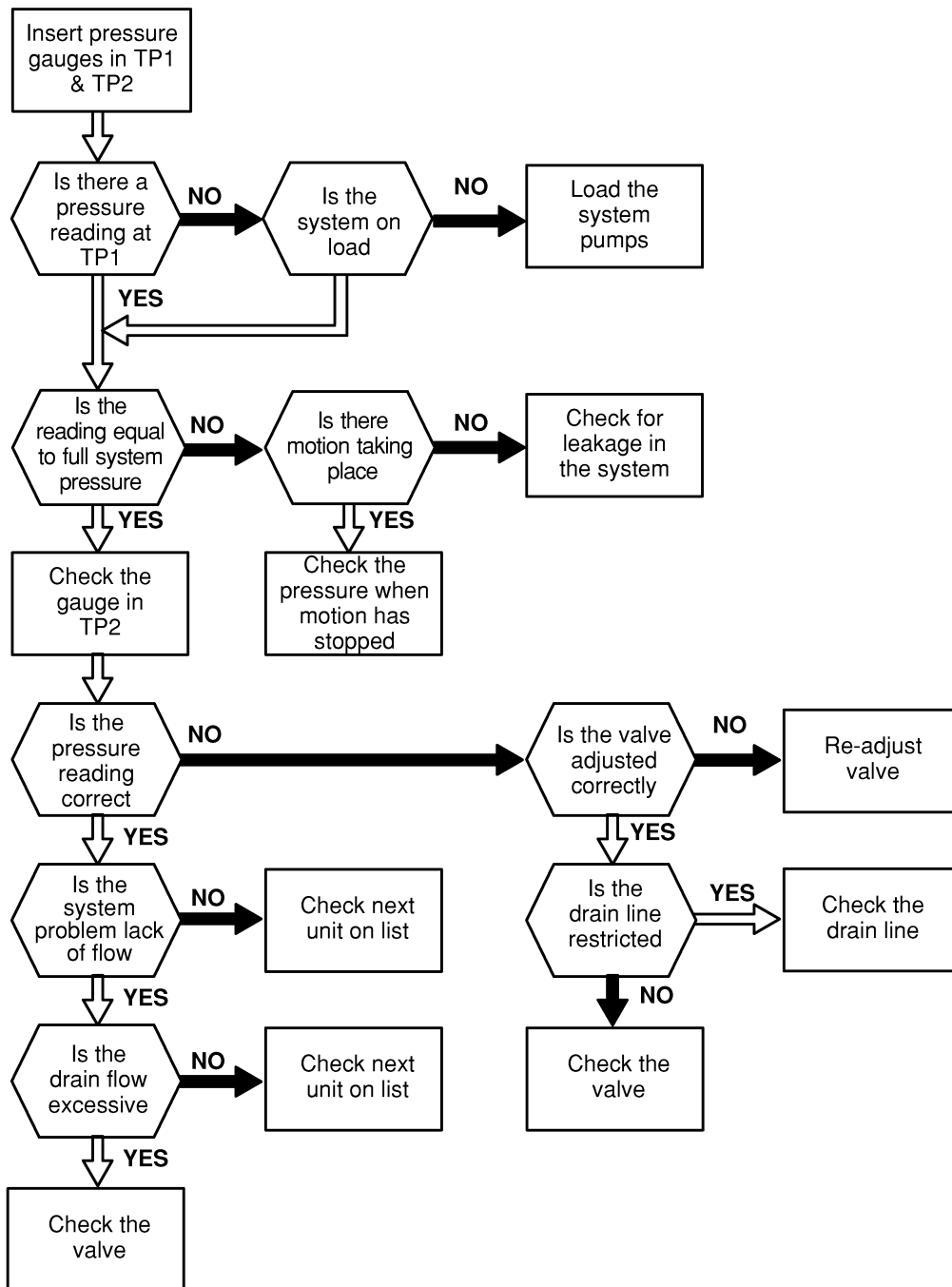
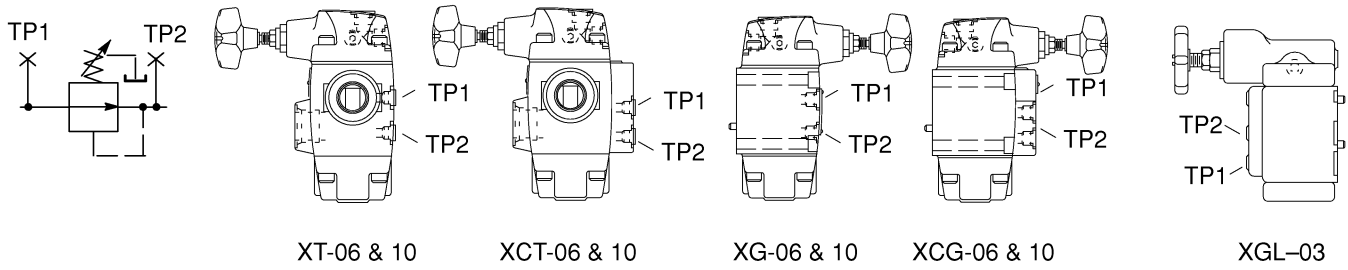

System test for flow control valves

Algo C.1

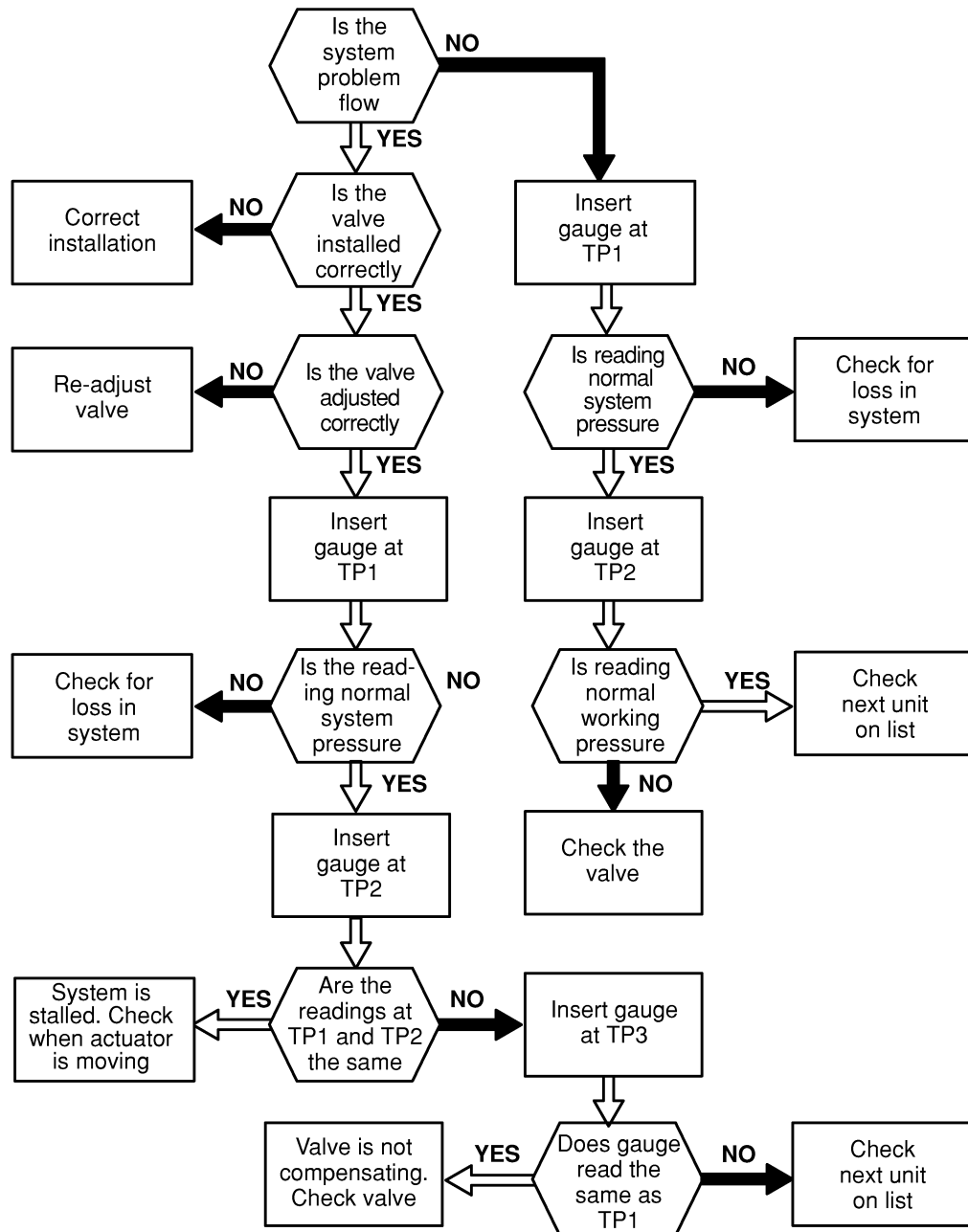
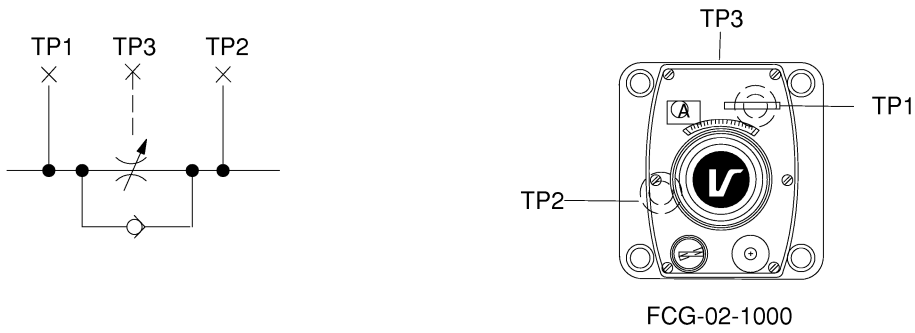

System test for directional control valves

Algo D.1

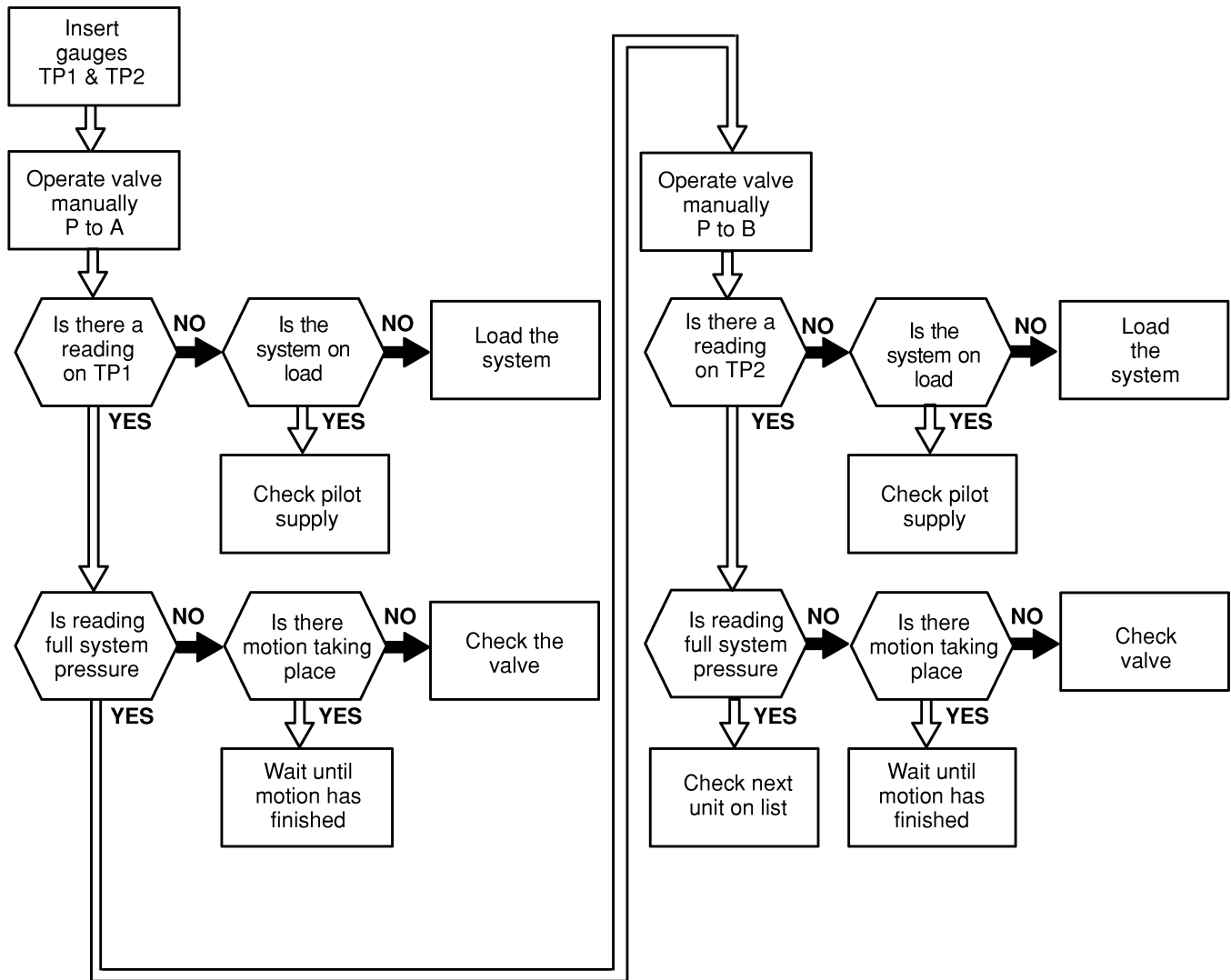
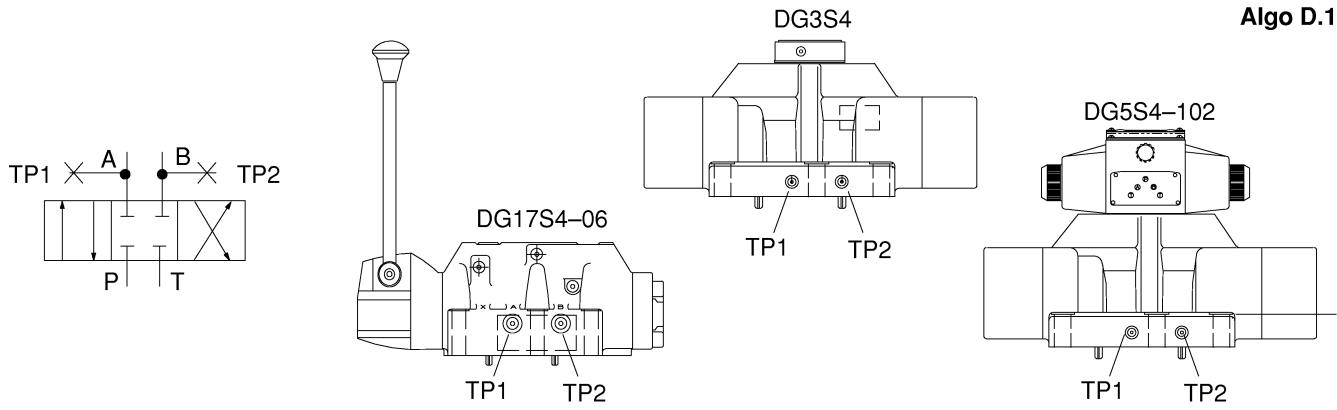

System test for pilot operated check valves

Algo E.1

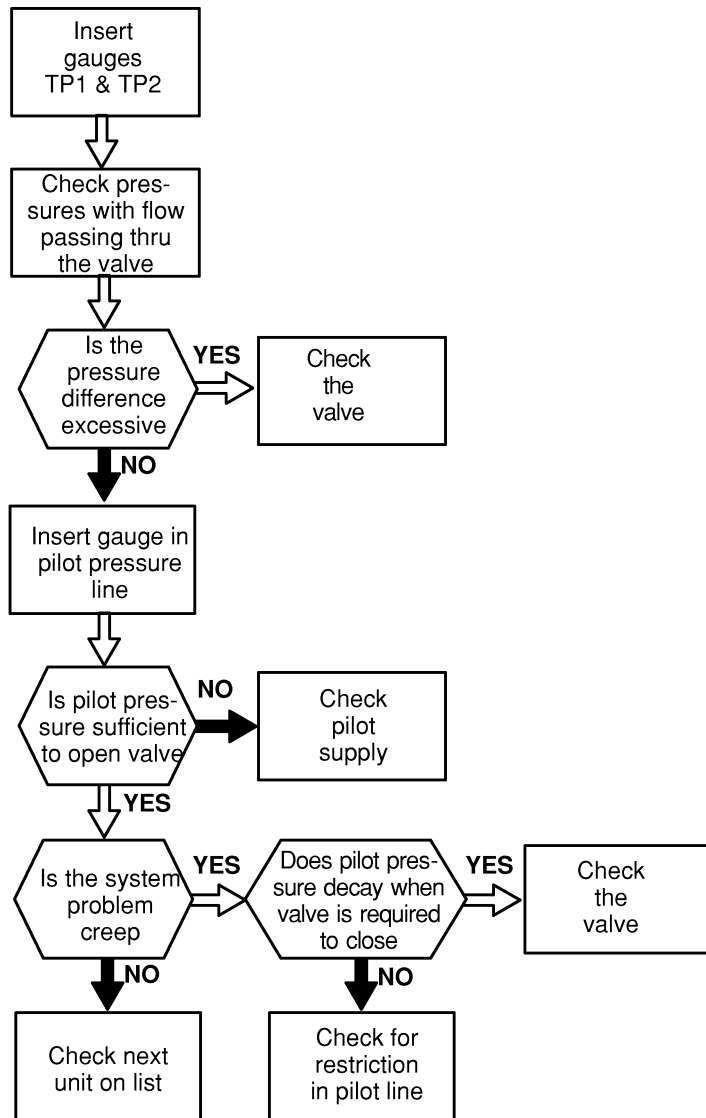
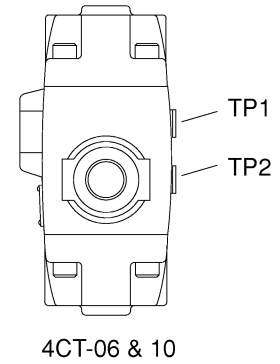
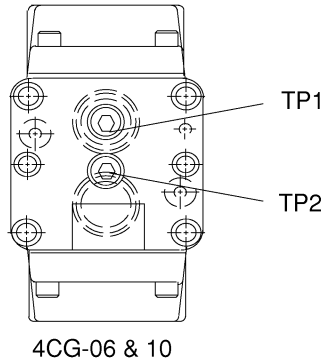
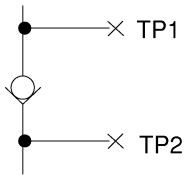

System test for cylinders

Algo G.1

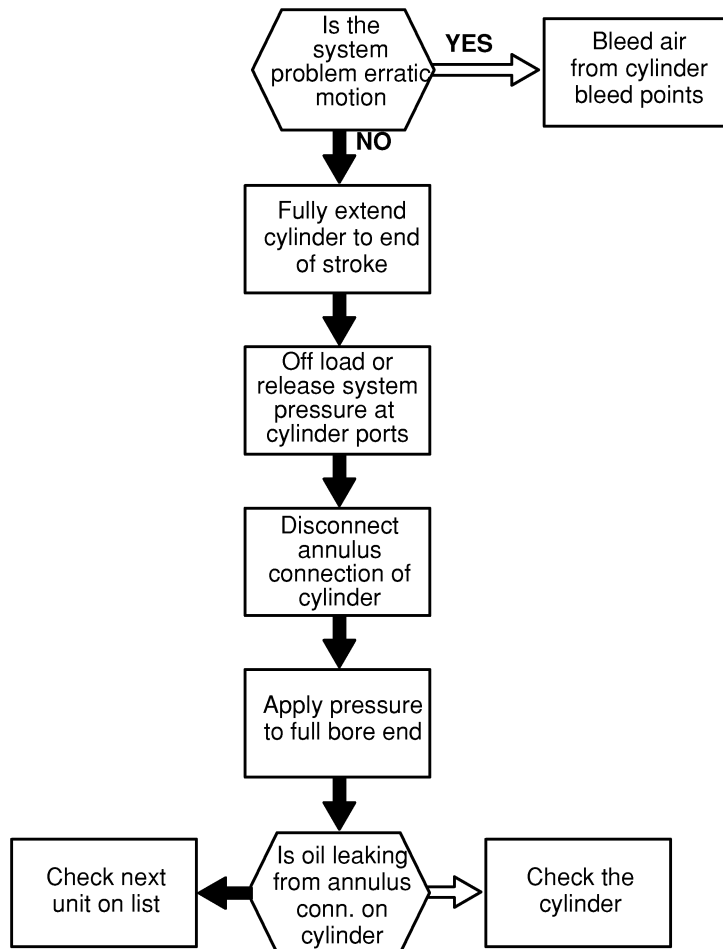
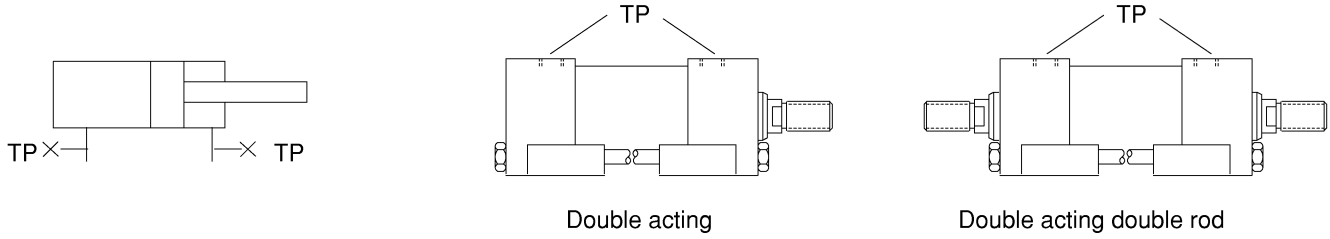

System test for hydraulic motors

Algo G.2

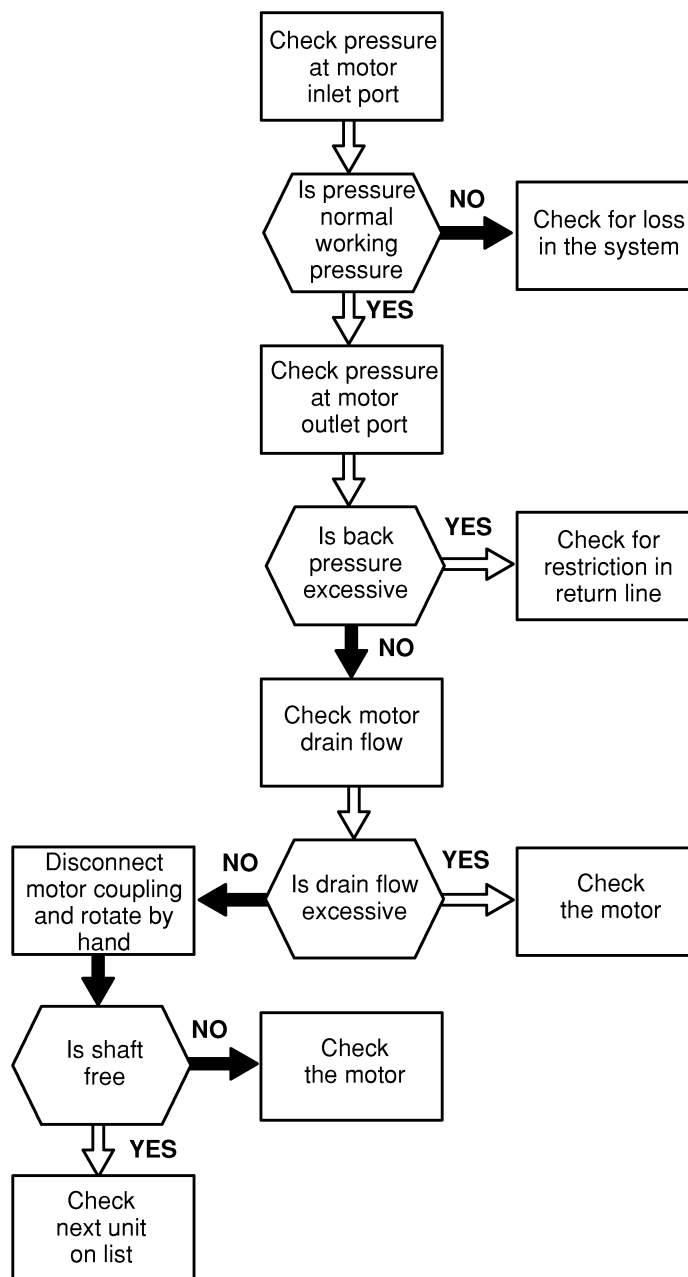
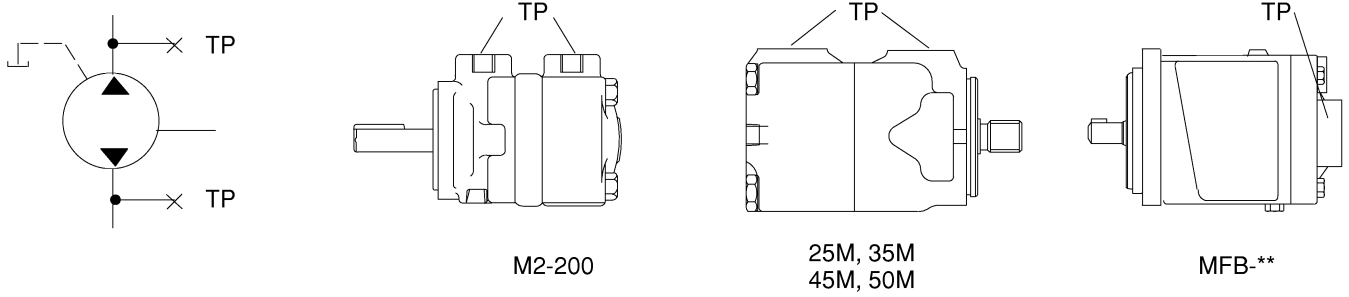

System test for accumulators

Algo J.1

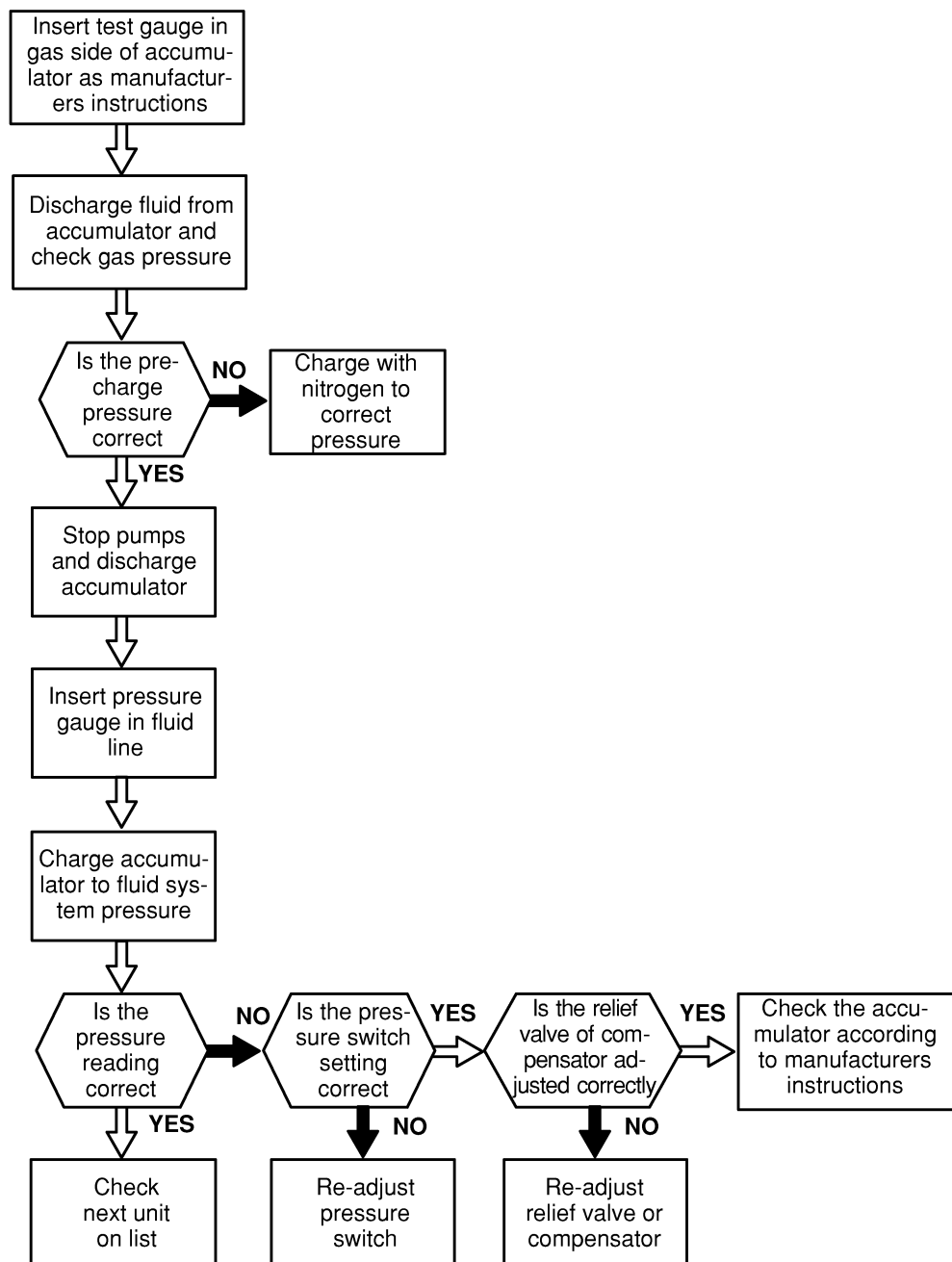
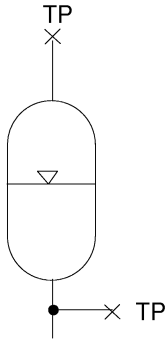

System test for coolers

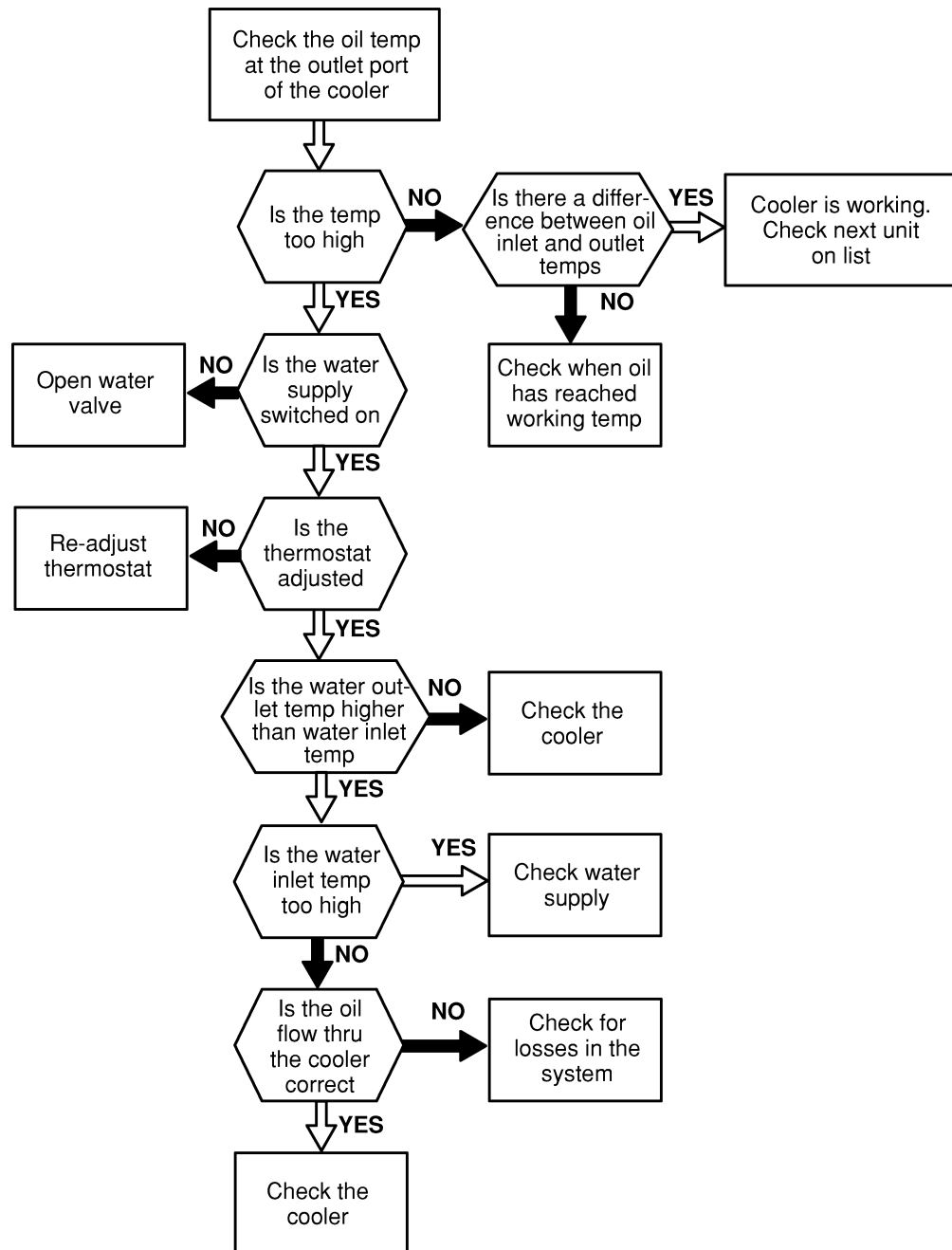
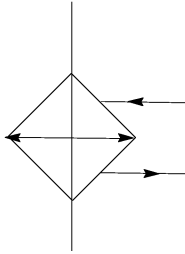

System test for air leaks

Algo L.1

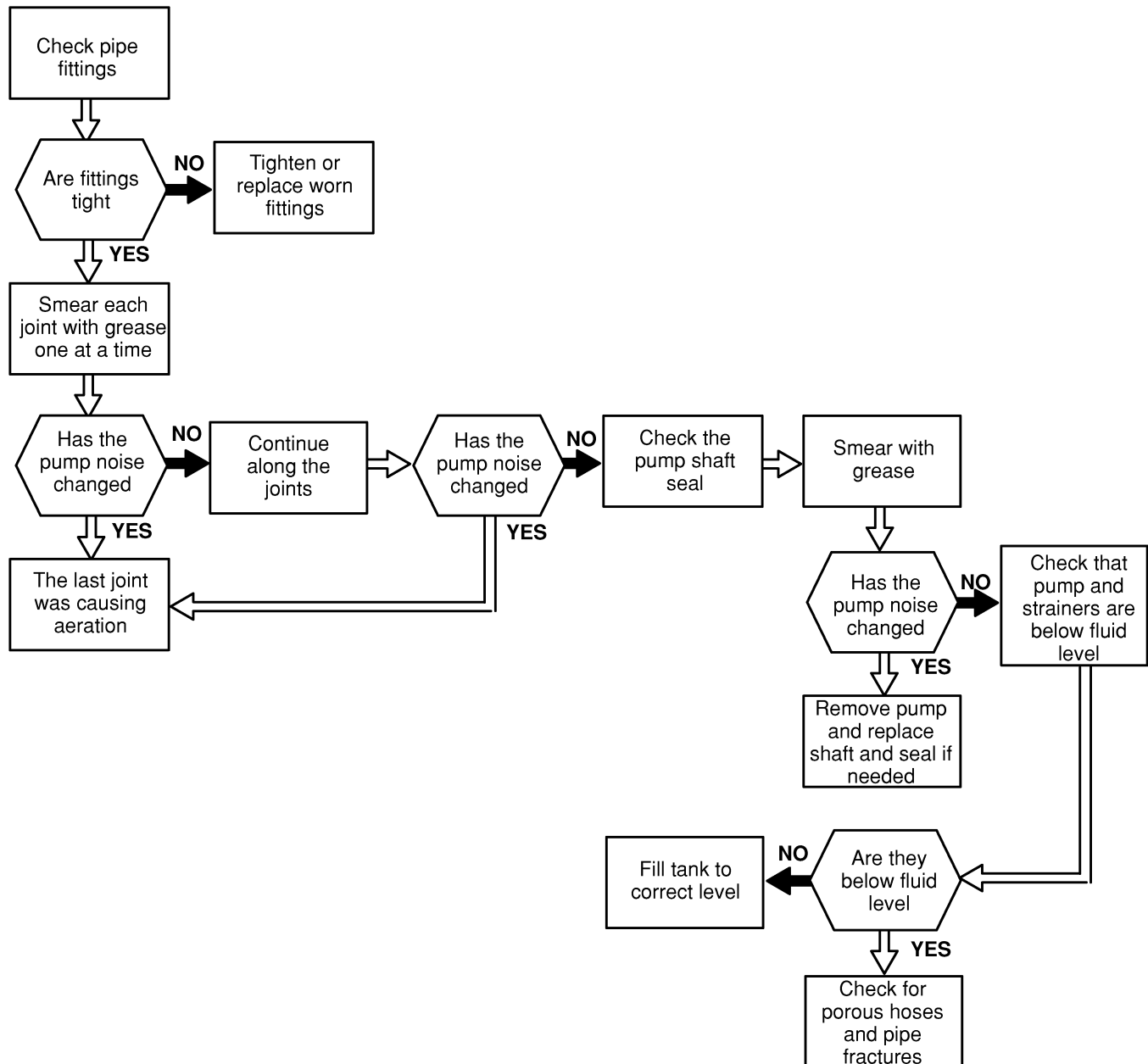

System test for fluid contamination

Algo L.2

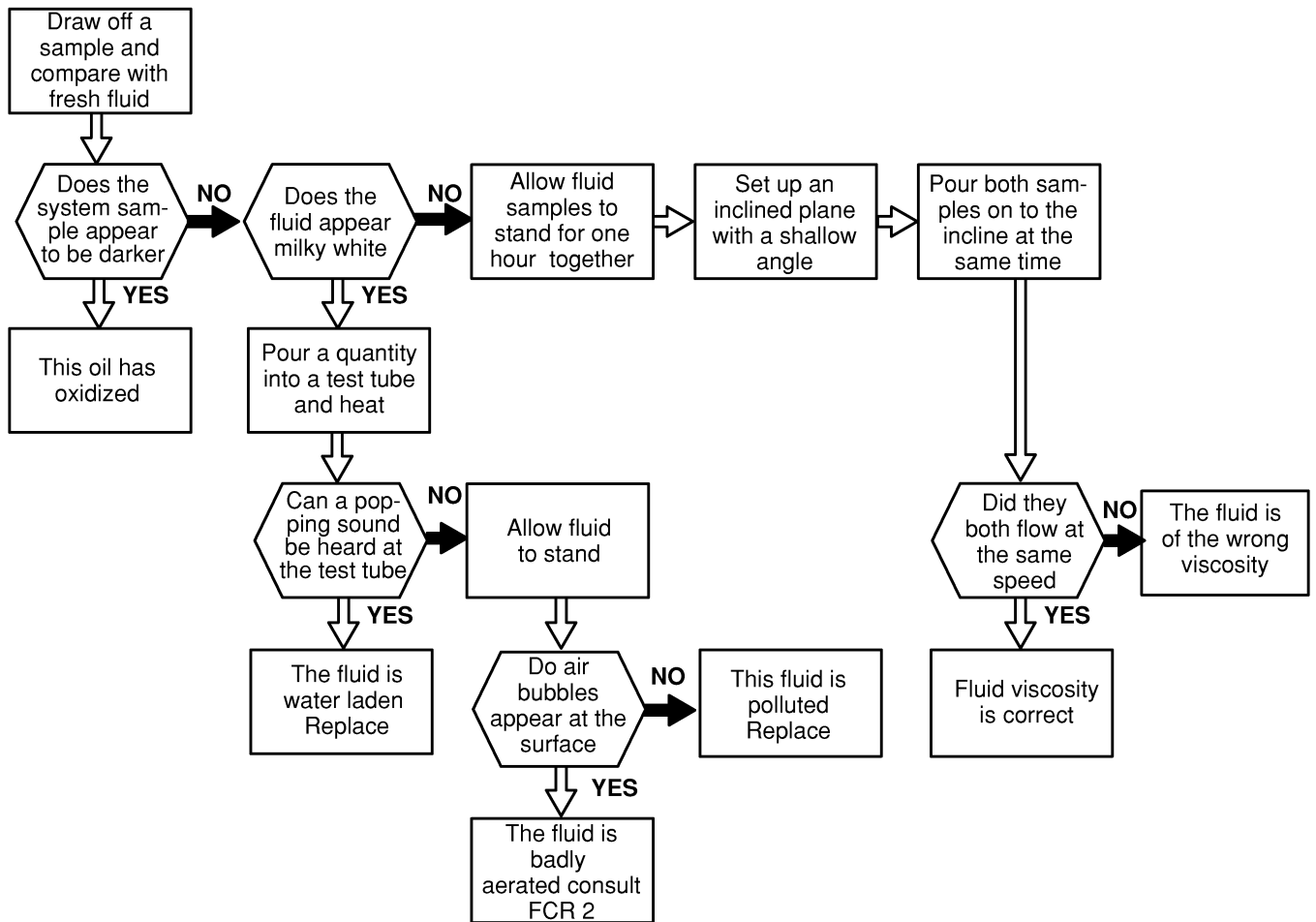

Pump cavitation

FCR 1

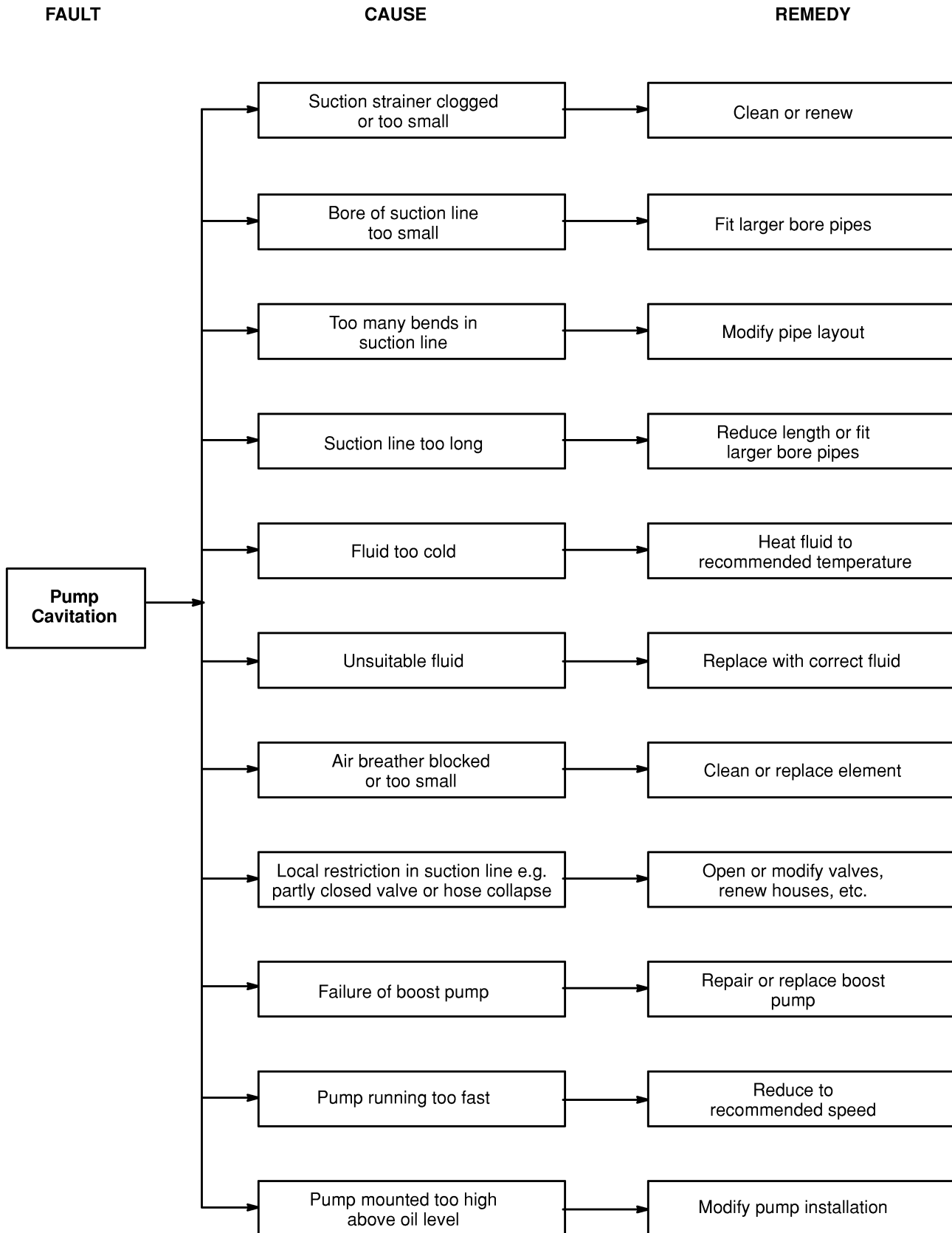

Aeration of fluid

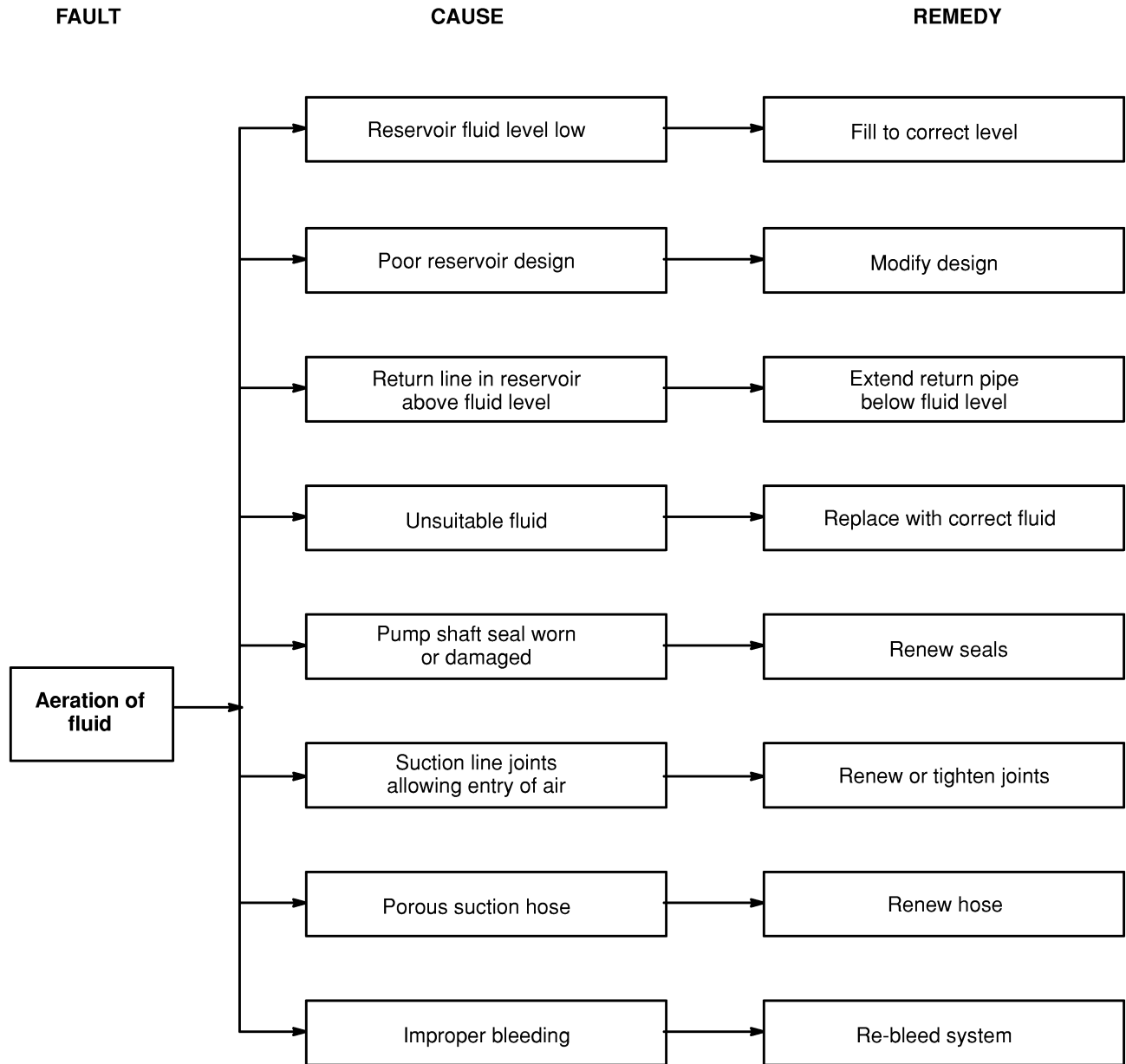

Re-start procedure

Algo 0.6

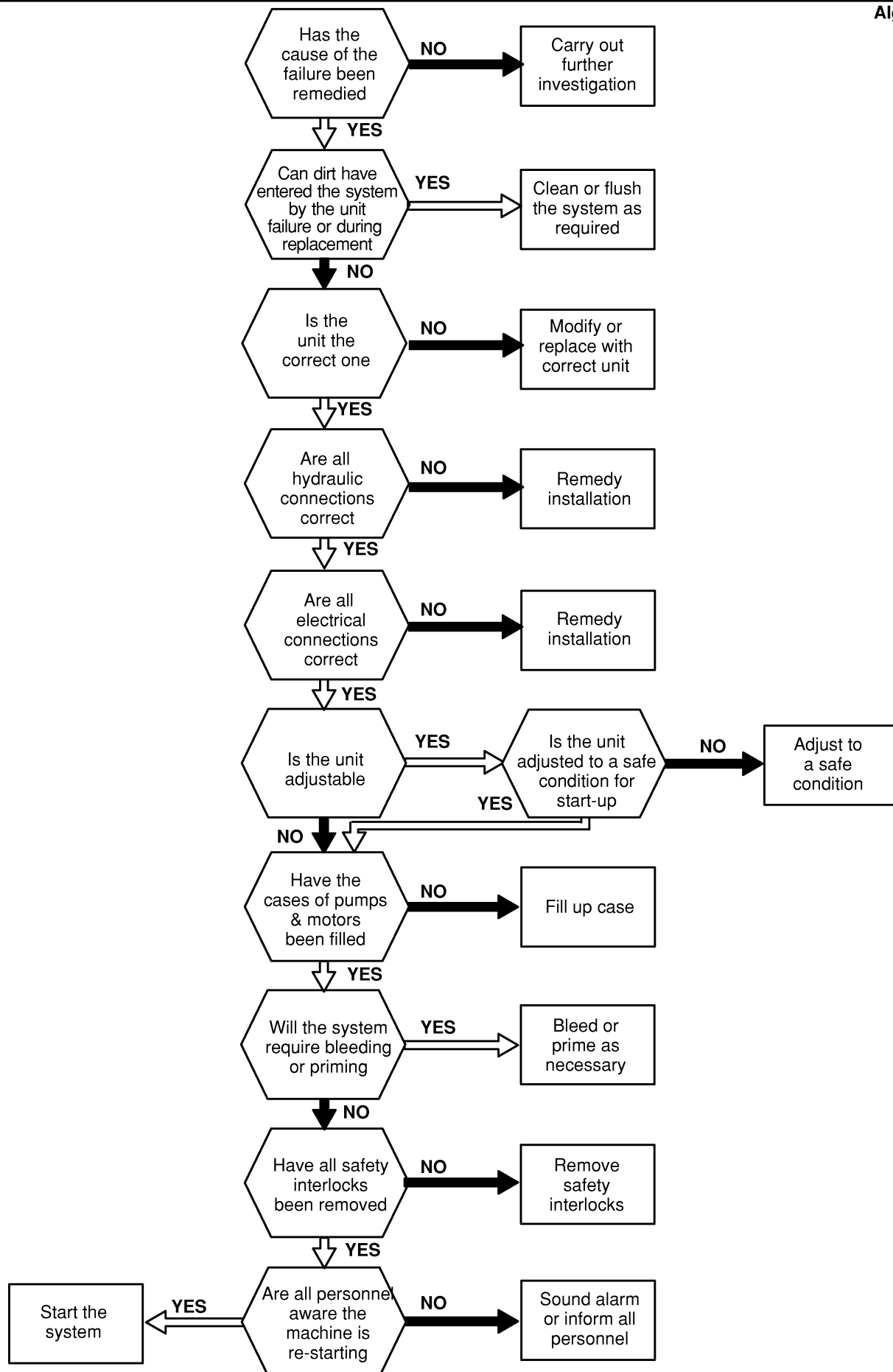

Bar trimming machine – Troubleshooting exercise

Introduction

To illustrate the procedure described in this book, an example will be worked through in detail for a typical machine as shown on page 36.

The Bar Trimming Machine consists of a carriage which is driven backwards and forwards by a hydraulic motor. Mounted on the carriage is a traverse cylinder which moves a cutting torch across a metal bar. Two clamp cylinders hold the bar in place and a semi-rotary actuator pushes the bar onto a roller table at the end of the cycle.

Assume that the operator has reported three problems which occurred simultaneously and prior to which the machine was operating satisfactorily.

Symptoms

- The carriage drive motor is slow in both directions.
- The traverse cylinder is slow when extending.
- The system is running hotter than usual.

Starting Point

Start at the fundamental problem, i.e. the slow movement of the carriage motor and traverse cylinder, using the heat problem as a clue. Since two machine faults have occurred it is not impossible that two faults have occurred in the hydraulic system simultaneously. It is more likely however, that one fault in the hydraulic system is causing both machine faults. The logical procedure therefore is to look at each machine fault in turn and arrive at a list of units which may be responsible for that particular symptom then look for units common to both lists, i.e. units which could cause both symptoms.

Machine Fault 1.

Slow speed of carriage drive motor.

Step 1. The symptom is one of speed, therefore, the problem is Flow.

Step 2. Consult the circuit diagram and identify the units and their function.

Step 3. List the units that could affect the flow to the carriage drive motor.

(The object of this step is to narrow down the number of units to be checked as much as possible. It is important however not to apply too much judgement at this stage, since it is better to have a long list rather than a short one which misses out the vital unit.)

It is very easy to overlook a component when drawing up the list, so for most systems it is safest to go through the parts list numerically and consider each unit in turn.)

Referring to the circuit diagram on page 37 the following units may cause the problem:

Unit #	Comments
9	A partially closed inlet valve could starve the pump and hence the system of fluid (Under these circumstances the pump would probably be cavitating and hence noisy but as mentioned above. Do not apply too much judgement at this stage.)
10	A blocked inlet filter could cause the same effect
11	Low output from the pump would affect the carriage drive motor since the flow to the motor is not throttled by any flow control valves.
13	A partially closed shut-off valve may have the same effect as a low pump output.
16	A partially closed check valve will also have the same effect.
17	A leaking relief valve again reduces the effective pump output.
18	A blocked return line filter may restrict the exhaust flow from the motor. (Although a by-pass is fitted, the filter may have been installed the wrong way around.)
20	It can be assumed that the purpose of the accumulator in this system is to supplement the pump flow, therefore an incorrect pre-charge pressure may affect the flow rate from the accumulator.
21	A partially closed isolating valve would tend to restrict the flow from the accumulator and hence to the motor.
22	A blow-down valve left open would reduce the effective flow from both the accumulator and the pump.
30	A directional valve leaking P to T could reduce the flow to the carriage drive motor.
31	As above.
34	An excessive leakage down the drain line of the pressure reducing valve could again reduce the flow to the carriage drive motor.
35	A restriction in the directional valve controlling the carriage drive motor (caused by a large piece of swarf, incomplete spool movement or wrongly adjusted stroke adjusters for example) could reduce the flow to the motor.

Unit #	Comments
36 & 37	Although a leaking relief valve may affect the flow to the motor, two faults would have to occur to affect the speed in both directions ie. either 36 & 37 both leaking or 36 & 38 leaking or 37 & 39 leaking. While this is not impossible, it is probably very much less likely.
40	As for 30 and 31.
42	As above.
48	A worn or damaged motor having excessive drain leakage would reduce the effective flow to the motor.
49 & 50	From the solenoid energization chart it can be seen that neither the traverse cylinder nor the eject rotary actuator are operating at the same time as the carriage drive motor. Therefore, a leakage in either of these two actuators would not affect flow to the motor.
51	Because the clamp cylinders are held down under pressure when the carriage drive motor is operating (refer to solenoid energization chart) a leakage across the piston seals could affect the flow to the carriage drive motor.
52	As above.

Machine Fault 2.

Slow speed of traverse cylinder when extending.

Step 1. Again the symptom is one of speed, therefore the problem is Flow.

Step 2. Consult the circuit diagram and identify the units and their functions.

Step 3. List the units that could affect the flow to the traverse cylinder when extending.

Unit #	Comments
9	See Machine Fault 1.
10	See Machine Fault 1.
11	See Machine Fault 1.
13	See Machine Fault 1.
16	See Machine Fault 1.
17	See Machine Fault 1.
18	See Machine Fault 1.
20	See Machine Fault 1.
21	See Machine Fault 1.

Unit #	Comments Cont'd
22	See Machine Fault 1.
30	See Machine Fault 1.
31	See Machine Fault 1.
34	See Machine Fault 1.
35	See Machine Fault 1.
40	See Machine Fault 1.
42	See Machine Fault 1.
44	Failure of the by-pass check valve, i.e. jammed closed, in the flow control valve would restrict the flow to the traverse cylinder when extending.
49	A leakage across the piston seals of the traverse cylinder would reduce the effective flow rate to the cylinder.
51	See Machine Fault 1.
52	See Machine Fault 1.

The units common to both lists i.e. units which on their own could cause both machine faults are as follows:

9, 10, 11, 13, 16, 17, 18, 20, 21, 22, 30, 31, 34, 35, 40, 42, 51, 52

Therefore from a total of 52 units on the system the search has been narrowed down to 18 by doing no more than look at the circuit diagram, highlighting the importance of being able to identify and understand circuit diagrams.

Step 4. Arrange the list in order of checking

The order in which units are checked is purely arbitrary and may be influenced by such things as past experience, layout of components, position of gauges etc., however, some units will inevitably be easier to check than others.

- Shut-off valves can be checked very easily to ensure they are in the correct position, so these may come first on the list – **9, 13, 21, 22.**
- Assuming indicators are fitted to the filters, these can also be checked easily – **10, 18.**
- A pressure gauge is fitted to the pump outlet port so the setting of the pump compensator and relief valve can be checked quite readily – **11, 17.**
- A pressure gauge is fitted to reducing valve **34** so the setting of this valve can be checked – **34.**
- The clamp cylinders can be quickly checked for abnormal symptoms – **51, 52.**
- The directional valves can now be checked for any abnormal symptoms – **30, 31, 35, 40, 42.**

- Finally check valve **16** can be checked for abnormal symptoms giving the complete list in order as – **9, 13, 21, 22, 10, 18, 11, 17, 34, 51, 52, 30, 31, 35, 40, 42, 16.**

Step 5. Preliminary check

Before going to the trouble of fitting additional pressure gauges, flow meters, etc., or of removing pipework, there are certain things that can be checked with the instrumentation already installed, or with the human senses of sight, touch, and hearing. Unless this step is carried out, it is very easy to overlook what in hindsight appears a very obvious problem, i.e. look for the obvious first).

For each of the units on the list the following questions should be answered where applicable.

Is the Unit correct? (model number)

Is the unit installed correctly?

Is the unit adjusted correctly?

Is the external signal correct?

Does the unit respond to the signal?

Are there any abnormal symptoms (heat, noise, etc)?

Assume that the preliminary check is carried out for each unit up to the clamp cylinder **52**, which is unusually hot.

Step 6. Algotest.

Having discovered that one unit exhibits abnormal symptoms, i.e. heat, the unit can now be checked in more detail by referring to the system test sheet for cylinders i.e. **Algo G.1.** Assume that having removed the connection from the rod end of the cylinder and pressurized the full bore side fluid is found to be leaking from the rod end connection, i.e. the piston seals have failed.

Step 7. The failed unit has now been located and a decision can be made whether to strip the unit in situ and make a repair or replace the complete unit, removing the failed unit to the second line service area for further examination.

Step 8. *Think!*

Having made the repair or replaced the unit, thought should be given to both the cause and the consequence of the failure. Assuming the cylinder piston seals were damaged, the following questions should be answered before the machine is restarted:

What caused the seals to become damaged?

– contamination?

– heat?

– wrong seals?

– wrong installation? etc.

Will the failure have had any effect on the rest of the system?

– If the seal has broken up, have particles of rubber entered the system?

– Has the oil become overheated and oxidized?

– Have any valves been adjusted to compensate for the leakage and will now require re-adjusting, etc.

By thinking about the cause and the consequence of the failure, the same problem (or a consequential one) may be prevented at a later date.

Bar trimming machine layout

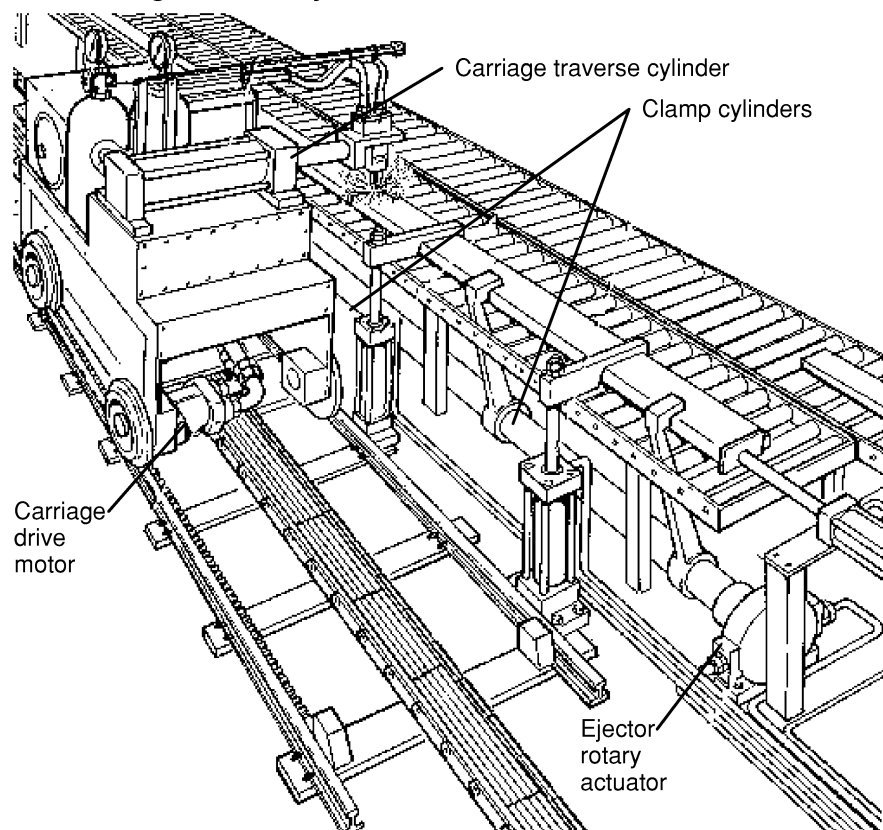

Circuit diagram for bar trimming machine

Solenoid Chart

Valve	30		31		35		40		42		17
Sol	a	b	a	b	a	b	a	b	a	b	a
0	0	0	0	0	0	0	0	0	0	0	1
0	1	0	1	0	0	0	0	0	0	0	1
0	1	0	1	0	1	0	0	0	0	0	1
0	1	0	1	0	0	1	0	0	0	0	1
0	1	0	1	0	0	0	1	0	0	0	1
0	1	0	1	1	0	0	0	0	0	0	1
1	0	1	0	0	0	0	0	0	0	0	1
0	0	0	0	0	0	0	0	1	0	0	1
0	0	0	0	0	0	0	0	0	1	1	1

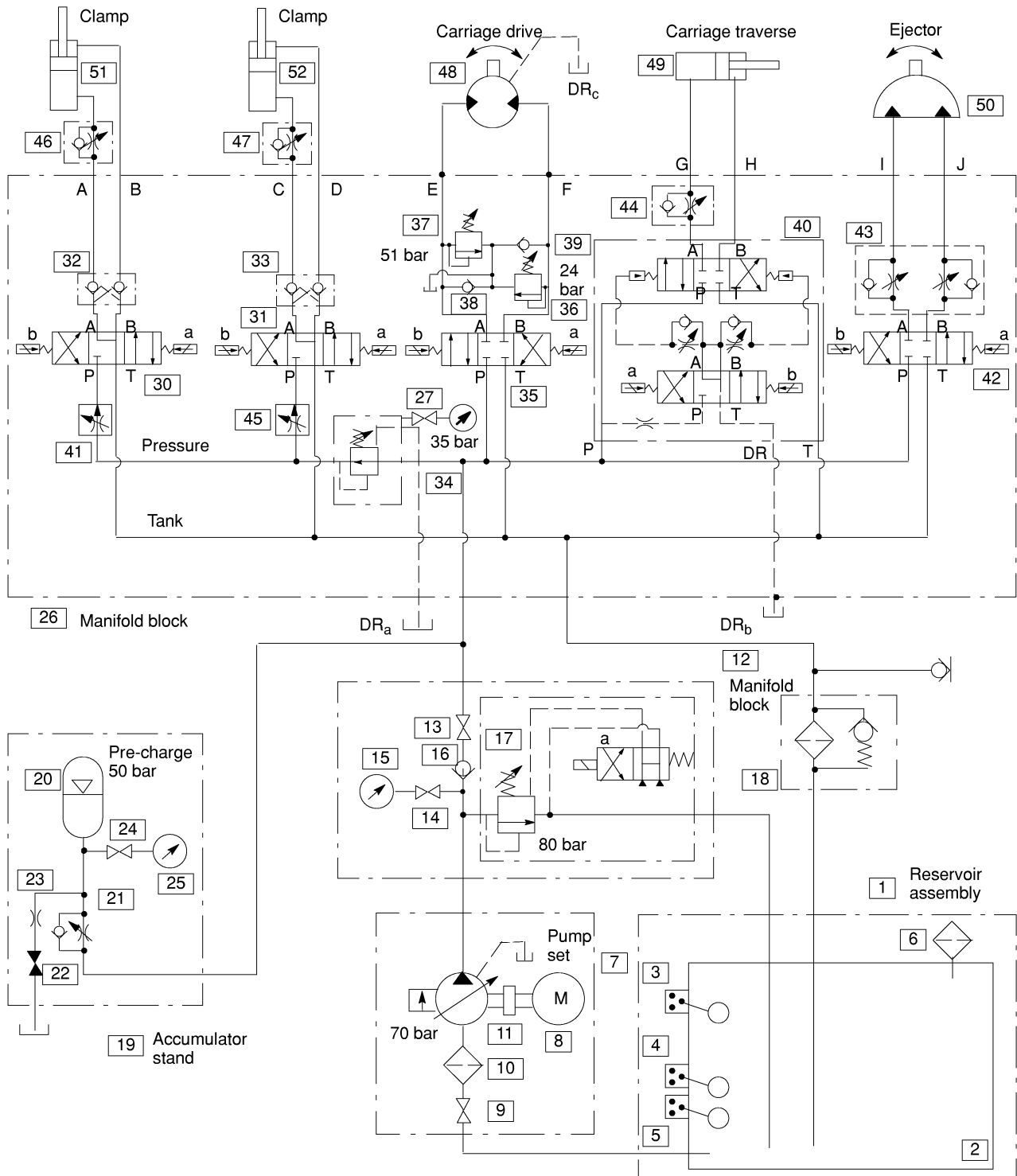

Eaton
14615 Lone Oak Road
Eden Prairie, MN 55344
USA
Tel: 952 937-9800
Fax: 952 974-7722
www.hydraulics.eaton.com

Eaton
20 Rosamond Road
Footscray
Victoria 3011
Australia
Tel: (61) 3 9319 8222
Fax: (61) 3 9318 5714

Eaton
46 New Lane, Havant
Hampshire PO9 2NB
England
Tel: (44) 23 92 486 451
Fax: (44) 23 92 487 110

